

2006

The viability of commercializing Wing-In-Ground (WIG) craft in connection with technical, economic and safety aspects followed by IMO legislation

Chin Su Paek
World Maritime University

Follow this and additional works at: http://commons.wmu.se/all_dissertations

 Part of the [Economics Commons](#)

Recommended Citation

Paek, Chin Su, "The viability of commercializing Wing-In-Ground (WIG) craft in connection with technical, economic and safety aspects followed by IMO legislation" (2006). *World Maritime University Dissertations*. Paper 42.

This Dissertation is brought to you courtesy of Maritime Commons. Items that have been designated as restricted to on-site patrons and members of the WMU community only may not be reproduced or hosted elsewhere. Both restricted and open access items are intended only for non-commercial, fair use academic purposes. For more information, please contact library@wmu.se.

WORLD MARITIME UNIVERSITY

Malmö, Sweden

**THE VIABILITY OF COMMERCIALIZING
WING-IN-GROUND (WIG) CRAFT IN
CONNECTION WITH TECHNICAL, ECONOMIC
AND SAFETY ASPECTS FOLLOWED BY IMO
LEGISLATION**

By

CHIN SU PAEK

Republic of Korea

A dissertation submitted to the World Maritime University in partial
Fulfillment of the requirement for the award of the degree of

MASTER OF SCIENCE

In

MARITIME AFFAIRS

(MARITIME ADMINISTRATION)

2006

DECLARATION

I hereby certify that all the material in this dissertation that is not my own work has been identified, and that no material is included for which a degree has previously been conferred me.

The contents of this dissertation reflect my own personal views, and are not necessarily endorsed by the University.

(Signature): 

(Date): 28 AUGUST 2006

Supervised by: Dr. Takeshi Nakazawa
Professor, World Maritime University

Assessor: Associate Prof. Jan-Åke Jönsson
World Maritime University

External Assessor: Dr. Knud Benedict
Professor, Wismar University, Germany

ACKNOWLEDGEMENTS

Above all, I give thanks to God Almighty for providing me with the strength, wisdom, patience, and good health for conducting my study successfully.

I am extremely grateful to the Government of the Republic of Korea (Civil Service Commission and the Ministry of Maritime Affairs and Fisheries) for affording an opportunity and providing the fellowship that made it possible for me to pursue this postgraduate degree.

My deepest gratitude to the World Maritime University MA Faculty, especially Vice-President Shuo Ma and Prof. Proshanto Mukherjee. Their dedicated instruction and encouragement inspired me to complete this dissertation.

A special gratitude goes to my supervisor, Prof. Takeshi Nakazawa for his patience, inspiring ideas, and dedicated supervision. I am really thankful for his enthusiasm and commitment.

I am also grateful to a Director of MOMAF, Young-Sun Park, for his inspiring guidance and encouragement.

I would like to thank the WMU library staff, especially Ms. Susan Wangeci-Eklöw and Ms. Cecilia Denne for assisting me in my work. Not to forget, to my WMU friends who directly or indirectly gave me support to realize this work, I am sincerely thankful.

Last, but not least, to my beloved wife Hyun-Mi, my daughter Ji-Young and my young son Min-Young, I say thanks for your unfailing love and patience during my study.

Title of Dissertation: **The viability of commercializing Wing-In-Ground (WIG) Craft in connection with technical, economic and safety aspects followed by IMO legislation.**

Degree: **MSc**

ABSTRACT

The dissertation is a study of the viability of commercialization of the Wing-In-Ground (WIG) craft, which is a novel type of marine transportation, currently being developed, so not yet commercialized in full scale.

A brief look is taken at present development, and at the historical overview of WIG craft. The main principles and technical issues of WIG craft are examined, taking into account whether there are technical barriers or not. On account of the inherent peculiarities of WIG craft, which possess the characteristics of both aircraft and ship, the legal status of WIG craft is obscure to some extent. The legal status of WIG craft is involved with IMO and ICAO, current international legislations and legal issues of WIG craft are examined.

Economic reasonableness for WIG craft is analyzed in both theoretical and practical methods. Economic efficiencies and effectiveness of WIG craft are evaluated by various theories. Directing operating costs are analyzed and evaluated, comparing the results of WIG craft obtained by the model with those of other vehicles for the purpose of examining economic reasonableness. Additionally, safety related matters which are essential for commercialization of WIG craft are discussed. A few recommendations are made to encourage commercialization of WIG craft.

KEYWORDS: WIG craft, Ground effect, Viability, Commercialization, Operating Cost, IMO, Economic, Efficiency, Regulations, Competitive, Feasibility, Safety.

TABLE OF CONTENTS

Declaration	ii
Acknowledgements	iii
Abstract	iv
Table of contents	v
List of tables	ix
List of figures	x
List of abbreviations	xii
CHAPTER ONE INTRODUCTION	1
1.1 Background and Historical Overview	1
1.2 Purpose	6
CHAPTER TWO MAIN PRINCIPLES AND TECHNICAL ISSUES OF THE WIG CRAFT	9
2.1 Introduction	9
2.2 Aerohydrodynamic Characteristics of WIG Craft	9
2.2.1 Ground Effect Phenomenon	9
2.2.2 Aspect Ratio	14
2.2.3 Breguet Range	16
2.2.4 Stability and Controllability	16
2.2.5 Hydrodynamic Drag and Power Requirement	18
2.2.6 Design Requirement	19
2.2.7 Propulsion	20
2.3 The Position of WIG Craft among Marine Vehicles	20

2.3.1	Development of Basic Types and Hybrids	20
2.3.2	Froude Number	22
2.3.3	Comparative Seaworthiness	23
2.4	Categorization of WIG Craft	25
2.4.1	Technical Categorization	25
2.4.1.1	Power Augmented Ram Wing in Ground Effect Craft	25
2.4.1.2	Dynamic Air Cushion Craft	26
2.4.1.3	Lippisch Type	27
2.4.1.4	Tandem Type	28
2.4.2	IMO/ICAO Categorization	29
2.4.2.1	Classified by Purpose	29
2.4.2.2	Classified by Aerodynamic Capabilities	29
2.5	Conclusions	30
CHAPTER THREE INTERNATIONAL LEGISLATION ON WIG CRAFT		32
3.1	Introduction	32
3.2	Review of IMO Actions	33
3.3	The Current International Regulation on WIG Craft	35
3.3.1	Legal Status of WIG Craft	35
3.3.2	Interim Guidelines for Wing-In-Ground (WIG) Craft	38
3.3.3	Revised COLREG 1972	39
3.3.4	STCW Recommendations on WIG Craft	40
3.4	Prescriptive Regulations vs. Safety Case Approach	41
3.5	Conclusions	45
CHAPTER FOUR ECONOMIC REASONABLENESS OF WIG CRAFT		46
4.1	Comparative Analysis	46
4.1.1	Karman-Gabrielli Diagram	46

4.1.2	Transport Productivity	50
4.1.2.1	Payload Ratio	50
4.1.2.2	Transport Productivity of High Speed Marine Vehicles	51
4.1.2.3	Fuel Consumption vs. Total Weight	52
4.1.3	Transport Effectiveness	54
4.1.4	Transport Factor	56
4.2	Cost Analysis of Modeled Routes	60
4.2.1	Introduction	60
4.2.2	Analysis Methodology	60
4.2.2.1	Assumption	60
4.2.2.2	Analysis Framework	61
4.2.3	Estimate of Total Direct Operating Cost	63
4.2.4	Modeled Scenario	65
4.2.4.1	Route	65
4.2.4.2	Vehicle Model	66
4.2.4.3	Calculated Results and Analysis	66
4.3	Conclusions	74
CHAPTER FIVE SAFETY RELATED MATTERS		76
5.1	Introduction	76
5.2	Operational Aspects	76
5.2.1	Safe Operating Height	76
5.2.2	Collision Avoidance	77
5.3	Human Element	81
5.3.1	Aviation Accidents vs. Maritime Accidents	82
5.3.2	Performance Levels	83
5.3.3	CRM vs. BRM	85
5.4	Safety Assessment	87

5.4.1	Safety Assessment Process	88
5.4.2	Safety Management	89
5.5	Conclusions	90
CHAPTER SIX _ CONCLUSIONS		92
REFERENCES		97
Appendices		
	Appendix A	104
	Appendix B	105
	Appendix C	106

LIST OF TABLES

Table 1.1	Current Prototype WIG craft	5
Table 2.1	WIG Craft Classified by Aerodynamic Capabilities	30
Table 3.1	The Fields of Competency of IMO and ICAO	37
Table 4.1	Comparison of Fuel Efficiency	52
Table 4.2	Transport Effectiveness	56
Table 4.3	Maximum Competitive Price of WIG craft in Case 1	68
Table 4.4	Maximum Competitive price of WIG craft in Case 2	72
Table 5.1	Relationship between Safety Assessment Processes and the Different Phases of the Development Cycle	88

LIST OF FIGURES

Figure 1.1	The Caspian Sea Monster (KM)	3
Figure 1.2	The Pelican Concepts	4
Figure 2.1	Creation of Wingtip Vortex	10
Figure 2.2	Formation of Lift and Drag	11
Figure 2.3	Aerodynamic Relations for angle of attack, lift and drag of a Wing	12
Figure 2.4	Lift to Drag Ratio versus Height above the Boundary	14
Figure 2.5	Effect of Aspect of Ratio and Relative Heigh	15
Figure 2.6	Speed vs. Relative Drag & Power & Cost of Vehicles	18
Figure 2.7	Advanced Marine Vehicles	21
Figure 2.8	Froude Numbers Corresponding to Marine Vehicles	23
Figure 2.9	Wave State and Performance of Fast Ships	24
Figure 2.10	Economic Seaworthiness of WIG crafts Compared to other Vehicles	25
Figure 2.11	A PARWIG Craft (A.90 Orlyonok)	26
Figure 2.12	A Dynamic Air Cushion Craft (Flightship 8)	27
Figure 2.13	Lippisch planform (X-114)	28
Figure 2.14	A Tandem type of WIG Craft (<u>Jörg VI</u>)	28
Figure 4.1	Specific Resistance of Single Vehicles	47
Figure 4.2	Lift-to-Drag Ratio for Different Locomotion	48
Figure 4.3	Required Power for Different Transport Vehicles	49
Figure 4.4	Payload Ratio versus Speed	50
Figure 4.5	Transport Productivity of High-Speed Marine Vehicles	51
Figure 4.6	Fuel Consumption of High-Speed Marine Vehicles vs. Total Weight	53
Figure 4.7	Vehicle Transport Factor	57
Figure 4.8	Fuel Transport Factor	58

Figure 4.9	Main components of Operating Cost	62
Figure 4.10	Direct Operating Costs of the Model Vehicles in Case 1	67
Figure 4.11	The Proportion of DOC 1 of Model Vehicles	67
Figure 4.12	Direct Operating Costs of Model Vehicles in Case 2	69
Figure 4.13	The Percentage of DOC 1 in the Total DOC of Model Craft	70
Figure 4.14	The Fuel Related Costs (DOC 2) of Model Craft	71
Figure 4.15	Comparison of DOC at Maximum Competitive Price of WIG craft	72
Figure 4.16	The Co-relation Between Speed and Maximum Competitive Price of WIG	73
Figure 5.1	Two Types of Maneuvers to Avoid Collision (a: Horizontal, b: Vertical)	78
Figure 5.2	Aircraft Accident by Primary Causes (Hull Loss Accident-World Wide Commercial Jet Fleet 1995 through 2004)	82
Figure 5.3	The Root Causes of Maritime Accidents	83

LIST OF ABBREVIATIONS

ACS	Air Cushion Ship
AGEC	Aerodynamic Ground Effect Craft
AIS	Automatic Identification System
AMSA	Australian Maritime Safety Authority
ARPA	Advanced Research Project Agency
BRM	Bridge Resource Management
COLREG 1972	International Regulations for Preventing Collisions at Sea 1972
CRM	Cockpit Resource Management
DACC	Dynamic Air Cushion Craft
DD	Dependence Diagram
DE	IMO Sub-Committee on Ship Design and its Equipment
DOC	Direct Operation Cost
FHA	Functional Hazard Assessment
FMECA	Failure Modes Effect and Criticality Analysis
FMES	Failure Modes and Effects Summary
GEM	Ground Effect Machine
GL	Germanischer Lloyd
HSC Code	High Speed Craft Code
ICAO	International Civil Aviation Organization
IMO	International Maritime Organization
ISM Code	International Safety Management Code
ITF	International Transport Worker's Federation
L/D	Lift-Drag Ratio
LL 66	International Convention on Loadline, 1966
MSC	Maritime Safety Committee

NASA	National Aeronautics and Space Administration
NTSB	The US National Transportation Safety Board Safety
PARWIG	Power Augmented Ram Wing in Ground Effect Craft
PSSA	Preliminary System Safety Assessment
SES	Surface Effect Ship
SOLAS 1974	International Convention for the Safety of Life at Sea, 1974
SOP	Standard Operating Procedure
SSA	System Safety Assessment
STCW 1978	International Convention on Standard of Training, Certification and Watchkeeping for Seafarers, 1978
TOC	Total Operating Cost
USCG	United States Coast Guard
VDR	Voyage Data Recorder
VTS	Vessel Traffic Service
WIG	Wing-In-Ground
WISE	Wing-In-Surface-Effect
ZHA	Zonal Hazard Analysis

CHAPTER ONE

INTRODUCTION

1.1 Background and Historical Overview

In 1967, a West intelligence found a strange looking craft with short wings and a very large tail in the Caspian Sea by satellite images which was neither fish nor fowl since it was shown to be analogues with an aircraft but very huge in size measuring over 90 meters and weighing about 550 tonnes moving just over the surface of the Caspian Sea at a phenomenal speed which had never been seen before. The craft was KM, also dubbed “*Caspian Sea Monster*” which was a design of the former Soviet Union.¹ For the secrecy policy of the Iron Curtain, the West prior to that time had not known this kind of craft developed by the former Soviet Union. After examining it, the West disclosed the characteristics of the *Caspian Sea Monster*, known as ground effect, an interesting natural phenomenon, resulting from the proximity to the vicinity of water surface or other surface, which improves the performance of the craft.

Wing-In-Ground (WIG) craft is the official term of this kind of flying ship using ground effect and is also known as an Ekranoplan (Russian for screen plane or low-flying plane),

¹ Losi, P. C. (1995). *The Wingship's Potential for Strategic Lift*. Washington, D.C.: National Defense University.

a Ram-wing craft, an Arcopter (Greek for curved wing), a WISE (Wing-In-Surface-Effect) craft, a Wingship, an AGECC (Aerodynamic Ground Effect Craft), a GEM (Ground Effect Machine) and a Flaircraft. WIG craft may be regarded as a flying ship because it is actually flying just above the sea.

Due to high water resistance the speed of a conventional ship, even fast marine vehicles such as hydrofoil ship and hovercraft, is limited up to 80-120 kilometers per hour.² However, as the WIG craft employs the effect of the ground effect, i.e. dynamic air cushion, during cruising, it can cruise without high water resistance at the highest speed among marine vehicles. Considering that the difference of density between water and air is in the ratio around one to eight hundred, it is clear that the resistance to WIG craft during operation considerably decreases.³

Historically, the concept of WIG craft started by T. Kaario, a Finnish engineer, who built the first WIG craft which he called “Wing-Ram” in 1935. The idea was followed by Troeing, a Swedish engineer in the end of the 1930s. However, it can be said that practical realization of the concept was made by R. Alexeyev, a renowned scientist of the former USSR as a precursor of the WIG craft in late the 1950s and early 1960s.

In 1966, as can be seen from Figure 1.1, the KM (510 tonnes), a full size WIG craft, nicknamed the “Caspian Sea Monster” was created by R. Alexeyev, which was the largest flying machine in the world at that time and remains the largest of WIG craft to

² Malyshev, M. I. (1995). Experience of Using Ekranoplans in Russian Navy. *In Proceedings of International Symposium for Twenty-First Century Flying Ships.* (pp.233-244). Sydney: The Institute of Marine Engineers.

³ Fischer, H., & Matjasic, K. (1997). The Hoverwing Technology Bridge Between WIG and ACV. *In Proceedings of International Symposium and Seminar for the Safety of High Speed Craft.* London: The Royal Institution of Naval Architects.

date.⁴ Granting that research and development of the WIG craft were pioneered by the Russian, it has been difficult for the Russians to further develop the WIG craft since 1991, due to drastic reduction of the budget of the Russian Navy with the breakup of the Soviet Union. By any means, it seems that Russian WIG craft are technically feasible but they are inadequate for civil use from an economic standpoint.⁵



Figure 1.1 - *The Caspian Sea Monster* (KM)

(Source: *The WIG Page* (2003))⁶

In the meantime, the research of WIG craft in Germany started in 1964. H. Fischer and A. Lippisch developed experimental WIG craft, i.e. X-112, X-113 and X-114. Moreover, in the USA, Steven Hooker, an aeronautical engineer and an analysis of US intelligence, who first observed *the Caspian Sea Monster* in 1967, has pursued a full scale WIG craft and founded his own company, *Aerocon*, to develop a huge WIG craft, the so-called *Wingship*, in 1984. Consequently, Hooker put forward five thousand tonnes of WIG

⁴ Sinitsyn, D., & Maskalik, A. (1996). The Ekranoplan is a New Type of High Speed Water Transport Which can be Used in All Seasons. *In workshop proceedings of Ekranoplan and Very Fast Craft*, (pp.152-161). Sydney: University of New South Wales.

⁵ Rozhdestvensky, K.V. (1995). Ekranoplans – Flying Ships of the Next Century. *In proceedings of International Symposium for Twenty-First Century Flying Ships*. (pp. 47-70). Sydney: The Institute of Marine Engineers.

craft which have fifteen hundred cargo capacities. However, the US Defense Advanced Research Project Agency (ARPA) ended it up halfheartedly in doubt about its feasibility.⁷

In connection with such a huge WIG craft, Boeing recently announced that a concept aircraft that is shown in Figure 1.2 has been under development.⁸ According to the plan, called “*Boeing Phantom Works*,” the craft, officially called the Pelican Ultra Large Transport Aircraft, might be the largest aircraft to ever fly. The craft has a normal cruising altitude of only twenty feet because it flies using ground effect. It will have a wingspan of 150 meters carrying up to 1400 tons of cargo. Considering its immense capacities and efficiencies, it is almost certain that the Pelican would actually take part in a competition with container ships when the concept is realized.



Figure 1.2 - The Pelican Concepts

(Source: *Boeing Frontiers*)⁹

⁶ The WIG Page. (2003). Retrieved June 30 2006, from <http://se-technology.com/wig>

⁷ Advance Research Projects Agency (1994). *Wingship Investigation Volume 1-Final Report*, ARPA Report, 30 September 1994.

Mellow, C. (1996, December/January). When Ship Have Wings: The Russians give the term “flying boats” a whole new look. *Air & Space*.

⁸ Cole, W. (2002, September). Phantom Works: The Pelican-A Big Bird for the Long Haul. *Boeing Frontiers*, Volume 1, Issue 5. Retrieved June 28, 2006, from http://www.boeing.com/news/frontiers/archive/2002/september/i_pw.html

⁹ *Ibid.*

On the other hand, since the 1980s smaller WIG craft have been developed for recreational and civilian uses. The prototype WIG craft of this kind which have been comparatively late developed are shown in Table 1.1. In addition, the research and development of WIG craft have been continuing in many countries, such as Australia, China, Germany, Japan, Korea (Republic of), Russia, Taiwan and the United States. However, even though discussions, research and development for WIG craft are done vigorously in the world, actual commercialization of WIG craft in real earnest has not been realized up to date.

Table 1.1 - Current Prototype WIG craft

Name	Country/ Manufacturer	Year	Weight/Seat	Speed	Purpose
Amphistar	Russia/MAC.		1900 kg/4 seat	80 knots	Recreational
Volga 2	Russia/SDPP	1986	2700 kg/10 seat	60 knots	Small Ferry
Jorg 6	Germany/Jorg	1991	3150 kg/7 seat	80 knots	Small Ferry
Airfish 3	Germany/F.F	1990	650 kg/	65 knots	Recreational
Hoverwing	Germany/T.T	1997	915 kg/2 seat	65 knots	
X-114	Germany/RFB	1977	1500 kg/6 seat	100 knots	Military
L-325	USA/Flarecraft		550 kg	65 knots	Commercial
Ram 902	China/CSSRC	1984	385 kg/1 seat	65 knots	Test
Galmaegy 4	Korea//KORDI	2002	4 seat	65 knots	Test

1.2 Purpose

Originally, the WIG craft was developed and researched with a view to using it for military rather than civil purposes mainly in the former USSR. However, these days the WIG craft has been arousing worldwide interest in civil and commercial uses. In this context, WIG craft has recently been under development for its commercialization in various countries, such as Australia, China, Germany, Italy, Japan, Korea (Republic of), Russia and the United States.¹⁰

Although the WIG craft seems a modern innovative form of maritime transport with the least possible water contact, it has not yet been commercialized on a full scale. It is because the introduction of such kind of unconventional marine craft is associated with risks and uncertainties related to technical feasibility and economic reasonableness and safety or environmental protection. Moreover, it is often insisted that only huge WIG craft, which can enter into direct competition with a conventional container ship, can be competitive; however, it may be impossible to develop such a huge WIG craft without practical operational experience of small WIG craft in association with technical, economic, and safety matters.

In this connection, the main purpose of this dissertation is to examine the viability of commercialization of WIG craft relating to technical, economic and safety aspects followed by legal issues. This paper is arranged as follows.

Having stated the objective and explained the background as well as a brief historical overview, the rest of this chapter gives a brief explanation of the framework of the dissertation.

¹⁰ Day, A. H., & Doctors, L. J. (1995). A Study of the Efficiency of the Wing-In-Ground-Effect Concept. *In proceedings of International Symposium for Twenty-First Century Flying Ships*. Sydney: The Institute of Marine Engineers.

Chapter two provides simplified study of the main principles and technical issues of WIG craft with a focus on aerodynamic characteristics of WIG craft. It then continues with a comparative study of other marine vehicles.

Chapter three deals with international legislation on WIG craft. It reviews IMO actions and legal status of WIG craft. It is noteworthy that until recently, there were no international regulations on WIG craft as well as the legal status of WIG craft was rather obscure. Needless to say that it clearly impeded the development and commercialization of WIG craft. Thus, it has been encouraging to see a series of the activities of IMO which amended 1972 COLREG and adopted the Interim Guidelines for WIG craft and the Recommendations for officers on WIG craft operations, albeit, the latter two are mere recommendations. Prescriptive and safety case approaches to enactment regulations on WIG craft are also discussed.

Chapter four analyzes economic reasonableness of commercial operation of WIG craft compared with aircraft and other marine vehicles. It focuses on comparative economic efficiency and reasonableness analysis using the classical Karman-Garbielli diagram and notions of transport productivity and efficiency as well as cost analysis of a modeled route. The comparative analysis of direct operating cost provides a point of reference about economic reasonableness of WIG craft.

Chapter five concerns safety matters including operational aspects, human element and safety assessment. Safety is one of the most important issues for commercialization of WIG craft. Therefore, it discusses in particular minimum height and collision avoidance. Moreover, considering that most of the marine as well as aviation accidents are caused by human error statistically, it is clear that the human element is of great importance. In this connection, Rasmussen's performance level and Cockpit resource management/

Bridge resource management are also focused on. Emphasis is also placed on safety assessment as well as safety management.

The last chapter provides conclusions based on the entire work. More specifically, it is a reflection on the real impact of promoting commercialization of WIG craft successfully and safely. It concludes with recommendations in expectation of materialization of commercial operation of WIG craft based on the reflection.

CHAPTER TWO

MAIN PRINCIPLES AND TECHNICAL ISSUES OF the WIG CRAFT

2.1 Introduction

More than ever before, the WIG craft has been stimulating international interest from practical as well as technical standpoints lately. As a matter of fact, granting that the WIG craft is an interesting area from a technical viewpoint, it may be said that provided the principle and technologies of the WIG craft are unattainable, there is nothing to be gained by a study of commercial viability for the WIG craft. In this connection, a simplified study of the main principle and technical issues of the WIG craft are given in this Chapter.

2.2 Aerohydrodynamic Characteristics of the WIG Craft

2.2.1 Ground Effect Phenomenon

To begin with, it is quite definite that the fundamental concept related to the WIG craft is the ground effect phenomenon. It is caused by a dense air cushion that is trapped between a wing and the ground when a wing approaches the ground, as a result, dynamic

lift force of the WIG craft increases, and thus, it needs less power and saves fuel. All aircraft when they take off or touch down pass through the ground effect phenomenon. As proof, pilots should be extremely cautious for fear that aircrafts may run out of runway for the extra lift power during take-off and landing.¹¹ The effect is also found in nature, e.g. birds and flying fish fly more efficiently by using this effect.¹²

When a wing is flying, high pressure is generated below the wing and low pressure above the wing. Indeed, the differential pressure between the surfaces of the wing makes lift that makes a wing fly as well as a swirl at both wingtips due to movement of air from the high-pressure side to the low side. A swirl occurring in a wingtip is called wingtip vortex or trailing vortex. Figure 2.1 shows how wingtip vortex works when a wing is flying.

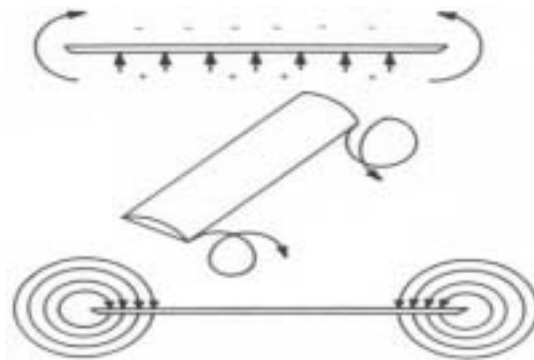

Figure 2.1 - Creation of Wingtip Vortex

(Source: *Scott (2003)*)¹³

¹¹ Greene, W. J. (1997). The Imminent Future of Ultra-Fast Ferries is Off The Water – Breakthrough Design Offers Better Efficiency & Maneuverability. *In proceedings of International Symposium and Seminar for the Safety of High Speed Craft*, London: The Royal Institution of Naval Architects.

¹² Advance Research Projects Agency. (1994). *supra* note 7.

¹³ Scott, J. (2003). *Ground Effect and WIG Vehicles*. Retrieved June 15, 2006, from Aerospaceweb.org, <http://www.aerospaceweb.org/question/aerodynamics/q0130.html>

In addition, when a wing is flying, the airflow moves downward because of the momentum of air mass. Being called downwash, it reduces the lift power generated by the wing. For compensating the reducing of lift caused by downwash, a wing must take a higher angle of attack and this increases a drag created by the wing. From Figure 2.2 it shows formation of lift (L), induced drag (D_i) from the resultant force (R) created by the wing's movement, the position of the wing and angle of attack.

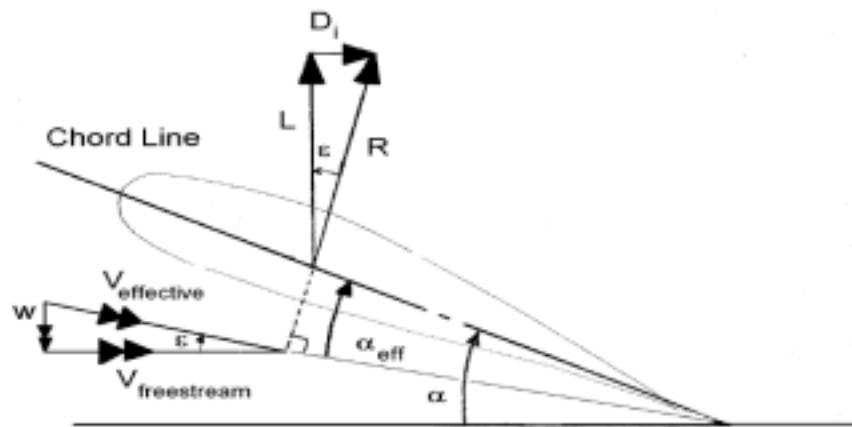

Figure 2.2 - Formation of Lift and Drag

(Source: Halloran & O'Meara (1999)¹⁴)

With an increase of angle of attack (α), coefficient of lift (C_L) increases, however, it is sharply decreased when angle of attack has reached the maximum limit. Besides, the coefficient of drag (C_D) due to increasing induced drag increases with an increase of the coefficient of lift (C_L). It can be seen in Figure 2.3, the relationship between the angle of attack, lift and induced drag.

¹⁴ Halloran, M., & O'Meara, S. (1999). *Wing-In-Ground-Effect Craft Review (Rep. No. DSTO-GD-0201)*. Melbourne: Defense Science & Technology Organization.

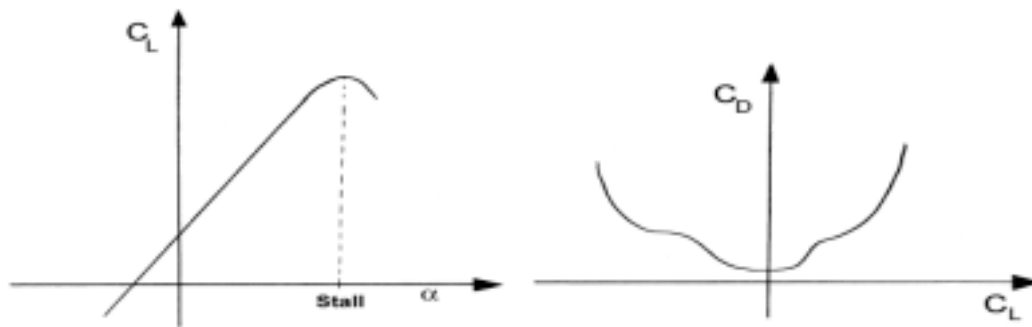

Figure 2.3 - Aerodynamic Relations for angle of attack, lift and drag of a Wing

(Source: Halloran & O'Meara (1999))¹⁵

Flight performance in ground effect can be expressed by the lift coefficient (C_L) and the drag coefficient (C_D) as follows.¹⁶

$$C_L = \left(\frac{W}{S} \right) \frac{1}{q} \quad (2.1)$$

where,

W/S – the wing loading (W : vehicle weight, S : lifting surface planform area)

q – dynamic air pressure ($\frac{1}{2}V^2$)

$$C_D = C_{D_0} + \frac{K(h)}{\pi \cdot A} \times C_L^2 \quad (2.2)$$

where,

¹⁵ *Ibid.*

¹⁶ Hooker, S. (1995). Twenty First Century Shipping at Aircraft Speeds. *In proceedings of International Symposium for Twenty-First Century Flying Ships.* (pp.178-232). Sydney: The Institute of Marine Engineers.

C_{Do} – the sum of the viscous drag and another component

$\frac{K(h)}{\pi \cdot A}$ – vortex drag factor ($K(h)$: a factor of relative height, A : aspect ratio)

In connection with the ground effect, as Chun et al. (1996)¹⁷ mentioned through their experimental study that:

“induced drag reduces as the wing approaches the ground due to the fact of the much reduced tip vortices hindered by the ground resulting in a reduction of the total drag”

when a wing closes the ground, the trailing vortices are blocked partially by the ground and downwashes are significantly decreased. As a result, the effective angle of attack increases. Finally, it results in increasing of lift and decreasing of induced drag. In other words, the ratio between the lift and the drag (L/D) that is ordinary used to show the efficiency of a craft increases in the ground effect. This is called the Ground Effect Phenomenon.

As above-mentioned, it is well known that the closer a wing is to the ground, the stronger the effect becomes. Relating to effective height above the ground, Carter (1961)¹⁸ carried out tests on wings in ground effect. The following graph taken from Carter shows the lift to drag ratio versus height above the boundary for two different wing cross sections. Indeed, it can clearly be seen the increase in lift to drag ratio with the wing closes the boundary. Also, it shows the positive influence of end plates that can

¹⁷ Chun, H., Park, I., Chung, K., & Shin, M. (1996). Computational and Experimental Studies on Wings in Ground Effect and a WIG Effect Craft. *In workshop proceedings of Ekranoplan and Very Fast Craft*, Sydney: University of New South Wales.

¹⁸ Carter, A. (1961). *Effect of Ground Proximity on the Aerodynamic Characteristics of ARI Aerofoils With and Without End Plates*. NASA TN D-970.

be installed on wings. It has been known that the ground effect phenomenon occurs only at about one wing chord distance from the ground.¹⁹

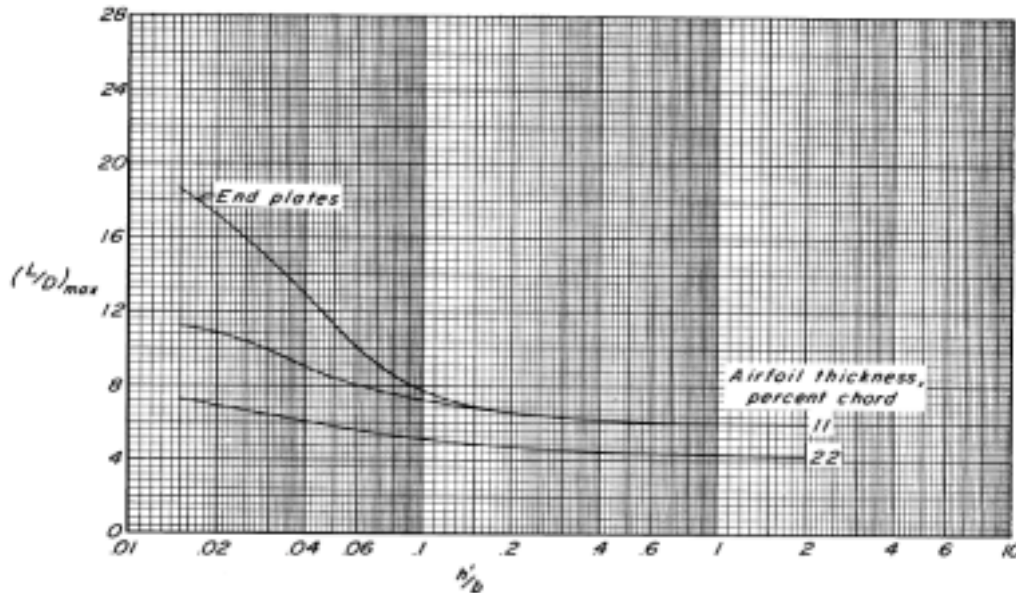

Figure 2.4 - Lift to Drag Ratio versus Height above the Boundary

(Source: Carter (1961))

As for the lift-drag ratio (L/D), which normally shows aerodynamic efficiency, typical L/D of subsonic aircraft is 15 to 20; however, L/D of WIG craft approximately reaches to 25 or 30 theoretically due to the ground effect phenomenon.²⁰

2.2.2 Aspect Ratio

It is also known that another important factor related to aerodynamic efficiency is the aspect ratio of a wing. It can be defined as the square of the span divided by the wing

¹⁹ Kornev, N., & Matveev, K. (2003). Complex Numerical Modeling of Dynamics and Crashes of Wing-In-Ground Effect Craft. In *proceedings of 41st Aerospace Science Meeting and Exhibit, Reno, Nevada*: American Institute of Aeronautics and Astronautics.

²⁰ Scott, J. (2003). and Hooker, S. (1995). *supra* note 13 & 16.

area. It is indicated how long and slender a wing is from tip to tip. From Figure 2.5, taken from Handler (1976)²¹, it can be shown that the effect of aspect ratio and relative height (h/c) at the wing tips on the dynamic quality, i.e. lift to drag ratio of a typical wing. It is clearly found that the higher the aspect ratio of a wing is, the more aerodynamic efficiencies of wing increase, let alone the above mentioned the influence of relative height above the surface. However, the WIG craft has generally low aspect ratio for stability problem.

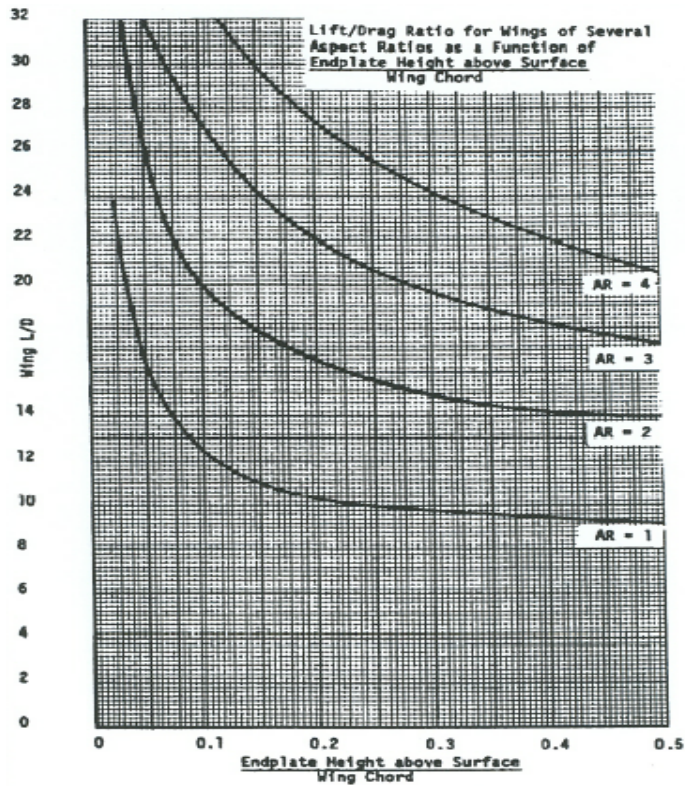

Figure 2.5 - Effect of Aspect of Ratio and Relative Height

(Source: Handler (1976))

²¹ Handler, E. H. (1976). Practical Considerations Regarding Wing-In-Ground Effect Aircraft. In *proceedings of Advanced Marine Vehicles Conference (A/AA/SNAME)*, Arlington, Virginia.

2.2.3 Breguet Range

It is known that the Breguet range is one of the traditional ways to analyze efficiencies of aircraft relating to its ability to carry a given payload over a given distance. The Breguet range is a very useful tool to verify theoretical benefits of the WIG craft due to the ground effect because it is straightly connected with a lift to the drag ratio of a craft. The Breguet range equation can be written as follows:

$$Range = \frac{\eta_p}{C_p} \cdot \frac{L}{D} \cdot \ln \frac{W_i}{W_i - W_f} \quad (2.3)$$

where,

η_p - propeller efficiency

C_p - specific fuel consumption

L/D - lift to drag ratio

W_i - initial weight

W_f - fuel weight

The Breguet range equation consists of three parameters that are efficiencies in terms of a propulsion system (η_p / C_p), an aerodynamics (L/D) and a structure & material of craft ($W_i / (W_i - W_f)$). As can be seen from the equation, it is obvious that the improvements of aerodynamics i.e. lift to drag ratio, will produce an effect on increasing the available range with a given payload.

2.2.4 Stability and Controllability

Owing to the peculiarity of WIG craft, which operate in the sea surface proximity, it is required that a high degree of stability and controllability should be achieved. Provided that stability and controllability are not proved sufficient enough for WIG craft, it is

apparently clear that commercialization of the WIG craft can not be realized but rather, it would be discarded.²² In fact, not only the WIG craft itself should be inherently stable, but also even a mistake in the WIG craft's operation is made, it should be easily detected and corrected.

Stability of WIG craft can be divided into three parts, i.e. height, pitch, and speed stabilities.. Height stability can be defined as “*the ability of a craft to maintain or return to its initial height after a disturbance in height.*”²³ For WIG craft, lift force and height from the ground are dependent on each other due to the ground effect. Thus, when the lift force is fluctuated caused by height variation, WIG craft should have a controllability of restoring original height considering the lifting force changes. Alternatively, it is required that the auto-pilot is used, which means the WIG craft can navigate with self-stabilization of operating height without any pilot involvement and this should be possible during its operation at constant speed in the ground effect. Since pitch stability of WIG craft is related to the height stability, it can cause danger of contact with the ground as well as high structural loads. It also causes ride discomfort to the passengers. Speed stability is the ability to maintain speed and control it. It is mainly dependent on height and incidence.

It can be said that stability and controllability are directly related to the safe operations of WIG craft. Although these problems seemed to be major technical barriers in the development of WIG craft in the past, these are not any longer technical obstacles of WIG craft with the current aeronautic technology relating to stability and controllability.²⁴

²² Chun, H.H., & Kim, H. J. (2000). Aerodynamic Optimization of Wing in Ground Effect Craft. *In proceedings of GEM 2000 International Conference (pp. 81-98)*, St. Petersburg: Marine Technical University and The Institute of Marine Engineers.

²³ Halloran, M., & O'Meara, S. (1999). *supra* note 14.

2.2.5 Hydrodynamic Drag and Power Requirement

It is clear that the efficiency of WIG craft under ground effect is higher than that of aircraft. Despite the advantage, the primary disadvantage derived from hydrodynamic drag is the large amount of power required to surmount the water drag for the WIG craft getting into the ground effect. What is worse, unlike aircraft, the WIG craft is not able to make use of the installed power entirely to increase the cruising speed during operation under ground effect.

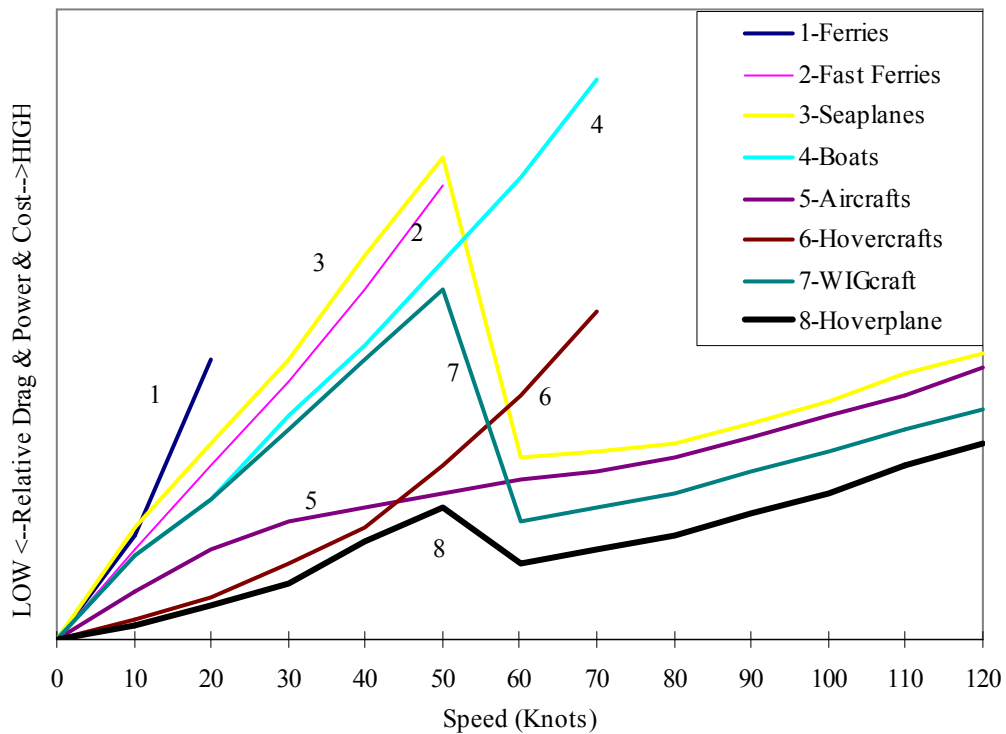

Figure 2.6 - Speed vs. Relative Drag & Power & Cost of Vehicles

(Source: Greene (1997))²⁵

²⁴ *Ibid.*

²⁵ Greene, W. J. (1997). *supra* note 11.

As can be seen from Figure 2.6, there is quite a high hump of WIG craft prior to take-off due to the craft's water drag. It is one of the main disadvantages of the WIG craft, which deteriorates efficiency of the ground effect. However, according to Greene, the water drag can be reduced through a specialized design and a lift-aids method as the hoverplane, which is a kind of WIG craft with an installed lift aids device.

2.2.6 Design Requirement

Needless to say that structural design of WIG craft is one of the most important matters because of its property of operating in two media, water and air. The WIG craft is under more severe conditions than ships and aircraft are. Therefore, it can be said that the design concept of WIG craft should be borrowed from schools of both aeronautics and naval architecture.²⁶ Design problems relating to lightweight structure, aerodynamics and control systems are suitable to be solved by aeronautical field experts and design problems involving hull design, water loads, maintenance of craft and operating in the water are suitable to be handled by naval architects.

Ando²⁷ says that there are three important requirements on the design of WIG craft. Firstly, it is suggested that the Power Augmented Ram concept be provided WIG craft with reducing the hump drag as well as more aerodynamically configured than the other conventional WIG craft. Considering such high drag prior to lift-off, it is necessary for WIG craft to have ability to overcome high water resistance.

Secondly, for avoidance obstacles during operating under ground effect, the ability of off ground effect flight is suggested. However, it is doubted whether it is requirement for

²⁶ Chubikov, V., Pashin, V., Treshchevsky, V., & Maskalik, A. (1991). Ekranoplan: A High-Speed Marine Vehicle of a New Type. *In proceedings of First International Conference on Fast Sea Transportation, (pp.641-648)*. Trondheim, Norway.

²⁷ Ando, S. (1988, May). Some Thoughts on Power-Augmented-Ram WIG Effect Vehicle. *Transactions of the Japan Society for Aeronautical and Space Science, (pp.29-37)*. Vol.31. No.91.

WIG craft because current technology makes it possible to avoid obstacles without ability of the off ground effect flight. It is also known that Germanischer Lloyd has already classified an eight-seater WIG craft without ability of the off ground effect flight.²⁸

Lastly, automatic maneuvering in ground effect flight is suggested to materialize maximum use of efficient and safety flight.

2.2.7 Propulsion

Required thrust and a particular operating environment decide the output and type of main engine of the WIG craft. The required thrust is the same as drag and is inversely proportional to $[1/ (L/D)]$.²⁹ Lift is equal to the weight of the WIG craft. The required power for take-off of the WIG craft is a determinant for selecting and designing the type and power of engines. The common aviation engines such as turbo prop, jet, and piston engines are used in WIG craft. However, it seems to be required for modification due to a particular operating environment. Generally, piston engines come into use for low power and low altitude, turbo prop engines for higher power at proper speed and jet engines, the most efficient ones, are used for high power at high speeds.³⁰

2.3 The Position of WIG Craft among Marine Vehicles

2.3.1 Development of Basic Types and Hybrids

Although the concept of WIG craft was invented in 1935 by the Finnish engineer G. Ka-

²⁸ Fach, K., Petersen, U., & Reischauer, H. J. (1999). Classification Experience with and 8 Seater WIG Craft. *In proceedings of Fifth International Conference on Fast Sea Transportation*, (pp.339-349). Seattle, Washington, USA.

²⁹ Stinton, D. (1997). Heavy, Long-Haul Operations Using the Air-Sea Interface. *In Proceedings of International Symposium and Seminar for the Safety of High Speed Craft*. (pp. 1-18). London: The Royal Institution of Naval Architects.

³⁰ Halloran, M., & O'Meara, S. (1999). *supra* note 14.

-ario is not new, the WIG craft is regarded as the most advanced marine vehicle in terms of transportation time that is the main characteristic of the quality of transportation service. Indeed, it can be said that marine transportation vehicles have been evolved for the sake of faster transportation time. It is a matter of course that safety and comfort is equal to the significance for passenger transport.

Advanced marine vehicles can be classified into four main physical concepts leading to the force balancing the weight of the ship, i.e. the hydrostatic buoyancy, the hydrodynamic lift, the aerostatic, powered air-lift and the aerodynamic lift forces.³¹ As can be seen from Figure 2.7, advanced marine vehicle concepts have been evolved in pursue of faster speed through interaction with each other. The WIG craft, the most advanced marine vehicles in terms of speed, is under the aerodynamic physical concept.

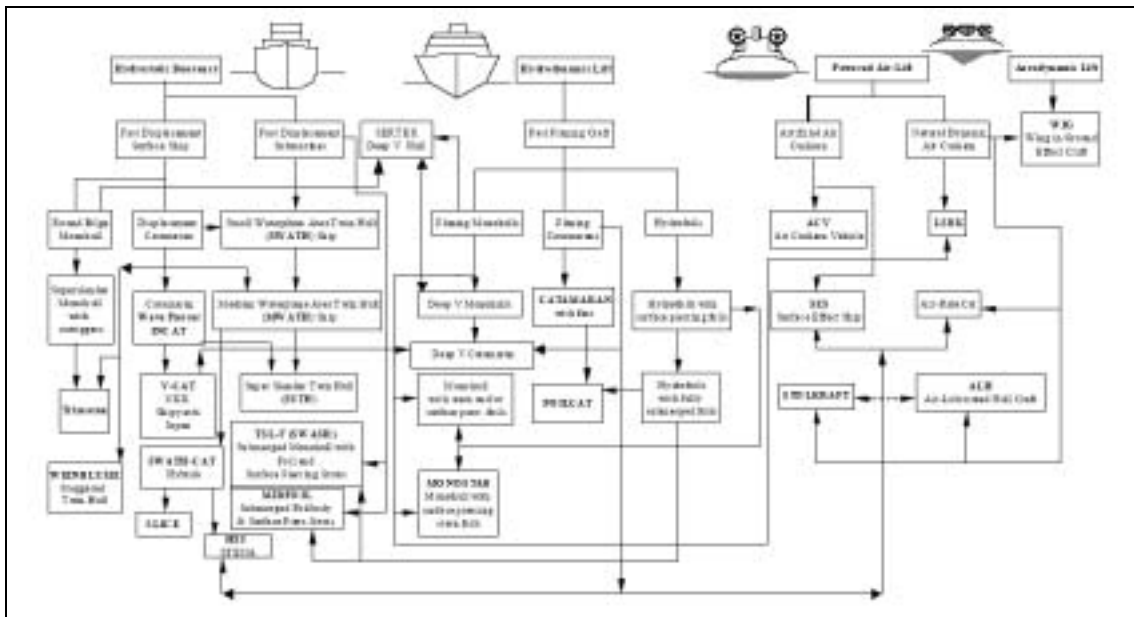

Figure. 2.7 - Advanced Marine Vehicles

(Source: Papanikolaou (2001))³²

³¹ Papanikolaou, A. D. (2001). Review of Advanced Marine Vehicles Concept. *In proceedings of Norwegian Maritime Technology Forum.*

³² *Ibid.*

2.3.2 Froude Number

The Froude number is a dimensionless parameter relating to a craft's relative speed and a craft's length or displacement. It can be interpreted as the ratio of the inertia force to gravity force in the flow, i.e. the inertial force divided by gravitational force. To put it another way, the Froude number indicates the relation between the viscous resistance and the wave resistance in a fluid. The viscous resistance becomes dominant at low Froude number, and at high Froude number the wave resistance dominates. The Froude number can be expressed as;

$$Fn = \frac{V}{\sqrt{g^3 \nabla}} \quad (2.3)$$

where,

V – velocity of craft, [m/s]

g – gravity acceleration, [m/s²]

∇ – displacement of craft [m³]

According to Basin et al.³³, the Froude number is the main parameter to typify bifurcation of vehicles from a dynamic point of view. It can be seen from Figure 2.8 that all marine craft can be classified by the ranges of Froude numbers. Conventional displacement ships whose velocity is under 30 knots have less than 1.5 of the Froude number and the one of the WIG craft is the highest among marine vehicles. Generally, the Froude number of seaplanes that fly at a speed of 200 to 400 knots falls to 20 to 35.

³³ Basin, M., Kramerov, E., & Latorre, R. (1997). WIG (Ecranoplane) as a Transport Vessel and Sport Craft. *In proceedings of International Symposium and Seminar for the Safety of High Speed Craft* London : The Royal Institution of Naval Architects.

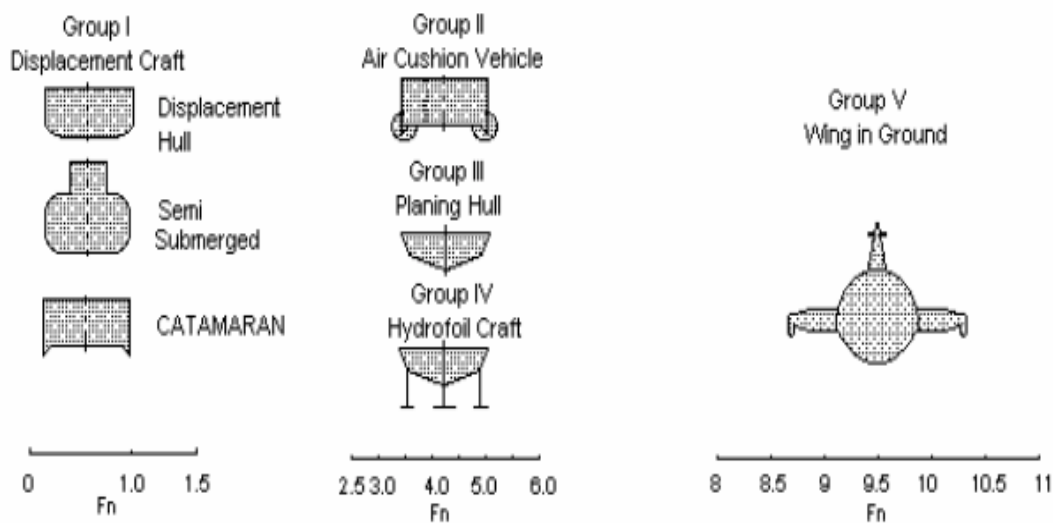

Figure 2.8 - Froude Numbers Corresponding to Marine Vehicles

(Source: *Advanced Vessel Technologies: The University of Alabama*)³⁴

2.3.3 Comparative Seaworthiness

It should be underlined that seaworthiness is a main factor for successful commercialization of the WIG craft. The reason is that it directly affects annual utilization of the WIG craft. Provided that the WIG craft has no satisfactory seaworthiness, there may after all be little viability of commercialization of the WIG craft. Moreover, it is also related to safety concerns. In general, WIG craft have more satisfactory seaworthiness than other fast ships. From Figure 2.9 it can be seen that the performance of seaborne fast ships have been much influenced by wave heights. However, the seaworthiness of WIG craft are little hampered by sea conditions because it navigates above the wave, albeit, it should fly higher to avoid contact with waves, which deteriorates efficiency of the ground effect.

³⁴ Advanced Vessel Technologies. (2000). Tuscaloosa: The University of Alabama.

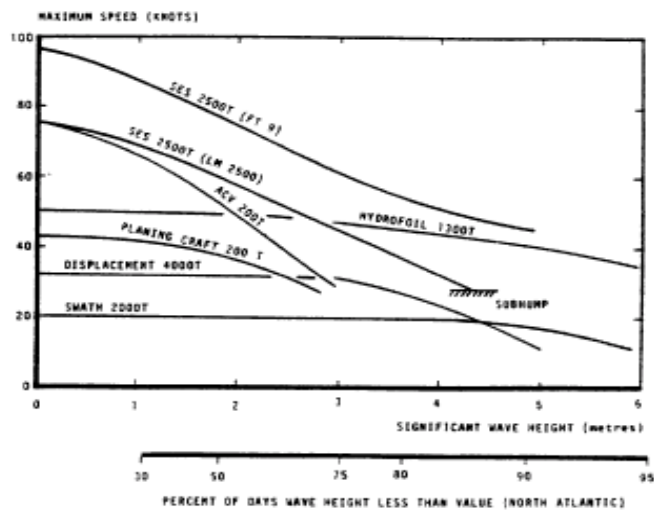

Figure 2.9 - Wave State and Performance of Fast Ships

(Source: Halloran, M. & O'Meara, S. (1999))³⁵

As a matter of fact, although the seaworthiness of WIG craft are practically little hampered by the wave conditions, economic seaworthiness, which means the operation in ground effect of the WIG craft should be considered so that economic efficiency of WIG craft will not be impaired. From this point of view, Rozhdestvensky has examined the seaworthiness of the WIG craft compared to other fast ships as follows. As can be seen from Figure 2.10, WIG craft have in general also satisfactory economic seaworthiness compared to other fast marine vehicles. However, small WIG craft have very limited seaworthiness because as mentioned in chapter 2.2.1 the distance between the wing and the ground, which is under influence of the ground effect, depends on the wing chord of the WIG craft.

³⁵ Halloran, M., & O'Meara, S. (1999). *supra* note 14.

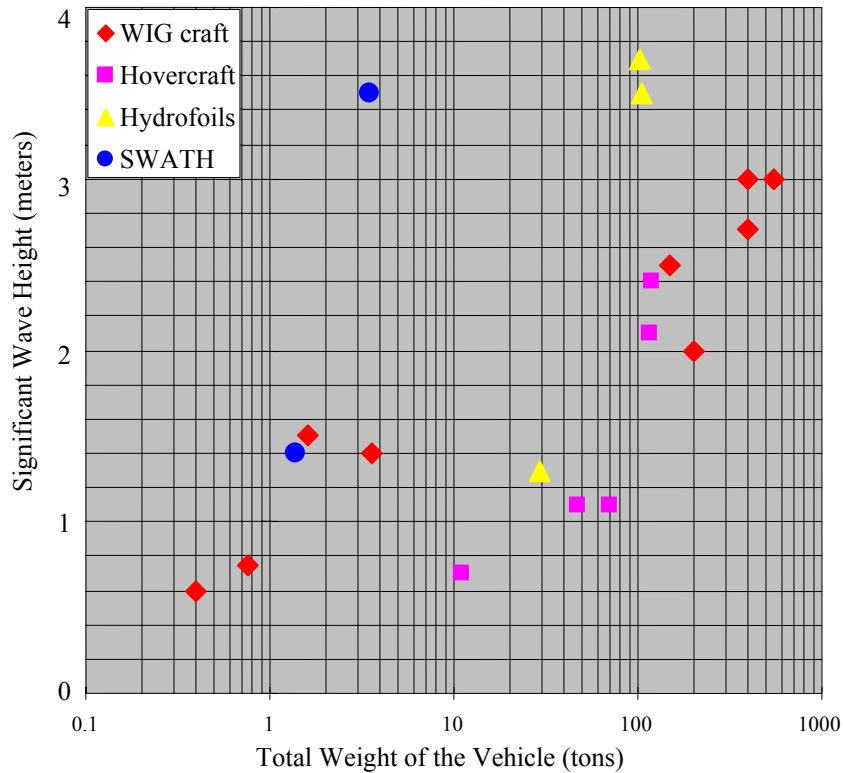

Figure 2.10 - Economic Seaworthiness of WIG crafts Compared to other Vehicles
 (Source: Rozhdestvensky (1996))³⁶

2.4 Categorization of WIG Craft

2.4.1 Technical Categorization

2.4.1.1 Power Augmented Ram Wing in Ground Effect Craft

As mentioned above, it might be said that one of the disadvantages of WIG craft is the high hump drag at take-off which results in high required power and extended take-off time and distance. In order to minimize the high hump drag at take-off, power assistance

³⁶ Rozhdestvensky, K.V. (1995). Ekranoplans – Flying Ships of the Next Century. *In proceedings of International Symposium for Twenty-First Century Flying Ships.* (pp. 47-70). Sydney: The Institute of Marine Engineers.

with a ram wing can be adopted. While the ram wing is in contact with the ground at the trailing edge, power assistance such as ducted propellers or turbofan feed pressurized air flow under the ram wing to reduce the hump drag at take-off. This is the so-called Power Augmented Ram Wing in the Ground Effect Craft (PARWIG) concept. Using this concept has made a number of WIG craft, in particular Russian Ekranoplans as can be seen from Figure 2.11.



Figure 2.11 - A PARWIG Craft (A.90 Orlyonok)

(Source: *The WIG Page (2003)*)³⁷

2.4.1.2 Dynamic Air Cushion Craft

Likewise hovercrafts, a pair of ducted air propellers fill the skirt of the WIG craft with pressurized air to generate the air cushion to lift the WIG craft. As a result the WIG craft can easily take off without high hump drag. After getting aerodynamic lift from the wings, there is no need to provide the wing with pressurized air. It also makes the WIG craft have amphibious availability. This type of WIG craft is the so-called Dynamic Air

³⁷ The WIG Page. (2003). *supra* note 6.

Cushion Craft (DACC), or dynamic hovercraft. Figure 2.12 shows one of the DACC type of WIG craft.



Figure 2.12 – A Dynamic Air Cushion Craft (Flightship 8)

(Source: *The WIG Page (2003)*)³⁸

2.4.1.3 Lippisch Type

In 1963, Alexander Lippisch, a German aviation engineer, developed the X-112, which was one of the first prototype WIG craft. The characteristic of the X-112 was the reversed delta wing with a low aspect ratio, which was known as the Lippisch planform. The reversed delta wing is very stable, which results in requiring only a small stabilizer compared to the ram wing craft. Figure 2.13 shows plans of the X-114, which is one of the Lippisch planform.

³⁸ *Ibid.*

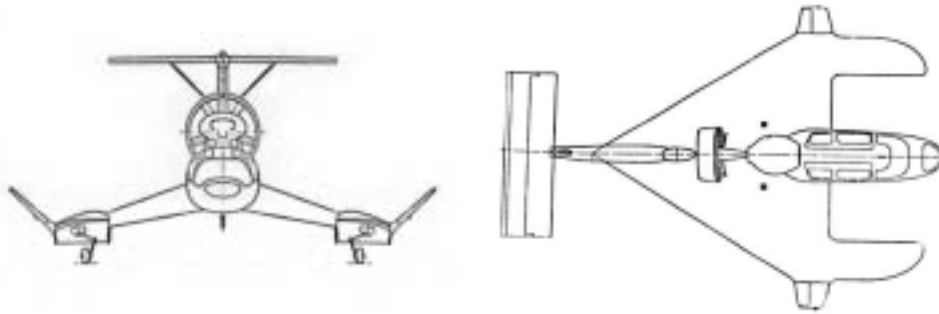

Figure 2.13 – Lippisch planform (X-114)

(Source: *The WIG Page (2003)*)³⁹

2.4.1.4 Tandem Type

The Tandem wing concept was developed in the USSR in 1960. It uses two small wings in line. Although there are some problems such as limited stability, low seaworthiness and high take-off speeds, the Tandem type WIG craft as a recreational river craft was developed in Germany.



Figure 2.14 - A Tandem type of WIG Craft (Jörg VI)

(Source: *The WIG Page (2003)*)⁴⁰

³⁹ *Ibid.*

2.4.2 IMO/ICAO Categorization

2.4.2.1 Classified by Purpose

In accordance with the Interim Guidelines for Wing-In-Ground (WIG) Craft, the WIG craft is classified by its purpose into two types, *viz* passenger craft and cargo craft. Like the definition of a passenger ship according to Regulation 2 of Chapter 1 of SOLAS 1974, WIG craft that carry more than twelve passengers are passenger craft and the other WIG craft are classified as cargo craft.⁴¹

In conjunction with the definition of passenger craft, the same concept as the HSC code⁴² in terms of rescue assistance has been introduced into the Guidelines for WIG craft. Where rescue assistance is readily available, e.g. within less than 4 hours, passive and active protection measures of the WIG craft for passengers and crews can be reduced. Such kind of craft is called assisted craft in the Guidelines for WIG craft and in the HSC Code it is classified into A passenger craft in the HSC Code.⁴³ On the contrary, where rescue assistance is not readily available, additional redundant safety systems including essential machinery is required. This kind of craft is named unassisted craft in the Guidelines for WIG craft and category B passenger craft in the HSC Code. According to the Guidelines, depending on the satisfaction of criteria and characteristics of Passenger WIG craft, it may be classified into assisted craft or unassisted craft.

2.4.2.2 Classified by Aerodynamic Capabilities

Apart from above categories of WIG craft, i.e. passenger or cargo craft, and assisted or unassisted craft, WIG craft are categorized by aerodynamic capabilities as follows.⁴⁴

⁴⁰ *Ibid.*

⁴¹ IMO. (2002). *Interim Guidelines for Wing-In-Ground (WIG) Craft*.

⁴² IMO. (2000). *The International Code of Safety for High-Speed Craft*.

⁴³ *Ibid.*

⁴⁴ IMO. (2002). *supra* note 41.

Table 2.1 – WIG Craft Classified by Aerodynamic Capabilities

Type of Craft	Aerodynamic Capabilities
Type A	Operation only in ground effect.
Type B	Temporarily fly-over capabilities but not exceeding 150 m above the surface.
Type C	Operation outside of ground effect and exceeding 150 m above the surface.

2.5 Conclusions

It is clear that WIG craft are theoretically more efficient than equivalent aircraft and faster than equivalent marine vehicles due to the ground effect. As is evident, the lift to drag ratio and Breguet range are able to prove higher efficiency of WIG craft. In the past, the main obstacles to develop the WIG craft were the problems relating to stability and controllability of it. However, it seems that these problems are not any longer technical deterrents these days with current aeronautic technology. The huge required power due to the considerable hydrodynamic hump drag of the WIG when it takes off is the primary disadvantage, which seriously deteriorates efficiencies of the WIG craft. . Thus, lift aids that make the WIG craft take off more easily should be required.

The Froude number is the main parameter to typify bifurcation of vehicles from a dynamic standpoint. The Froude number of the WIG craft falls to the range of eight to eleven which is the highest among marine vehicles. WIG craft have in general also satisfactory economic seaworthiness compared to other fast marine vehicles. However, small WIG craft have very limited seaworthiness.

WIG craft can be categorized technically and legally. It may be said that PARWIG, DACC, Lippisch and Tandem types of WIG craft are classified by aerodynamic

technology. IMO/ICAO also categorizes WIG craft into passenger/cargo craft, assisted/unassisted regarding rescue operation, and type “A”, “B”, and “C” relating to aerodynamic capabilities.

CHAPTER THREE

INTERNATIONAL LEGISLATION ON WIG CRAFT

3.1 Introduction

In the 1990s, the legal status of WIG craft was quite obscure whether the regulating body was aviation or maritime. The reason was that the WIG craft is fundamentally different from all existing marine vehicles. However, arrangement, engineering characteristics, design, construction and operation of WIG craft have something in common with those of aircraft, which resulted in complication of whether WIG craft should be classified as a ship or an aircraft. In the long run, in the early 1995, IMO and ICAO reached a conclusion that IMO was regarded as the appropriate regulating body for WIG craft.

On the account that the WIG craft, which is significantly different from a conventional ship in many aspects, could not be accommodated under traditional maritime safety instruments, such as SOLAS 1974 and LL 66 conventions, IMO faced the necessity for establishment of international standard rules on WIG craft. As Rozhdestvensky and Mikhailov suggested in their paper⁴⁵ “*without proper regulations and certifications, WIG craft would never be able to reach the customer.*” (Rozhdestvensky and Mikhailov,

⁴⁵ Rozhdestvensky, K.V., & Mikhailov, M.A. (1998). Virtual Na (WIG)ation. *In proceedings of Workshop on WISE up to Ekranoplan GEMs. (pp. 125-137).* Sydney : The Institute of Marine Engineers.

1998), surely, without international regulations on a transportation a vehicle which is intended to make international voyage for the purpose of commercial transport, it is practically not allowed to be put out to sea.

Moreover, it is quite essential for WIG craft to make proper international institutional device so that it can adequately support to commercialization of WIG craft. Besides, it can be said that any transportation can be accepted for commercial operation only if it has been inspected resulting in issuing corresponding authorized certificate. For this reason, legal problems arise when a novel type of transportation is introduced. In this connection, the WIG craft was confronted with a lack of international regulations until quite recently.

Recognizing the importance and necessity for enactment of regulation on WIG craft, IMO after all established the Guidelines for WIG craft as well as amended COLREG 1972 and STCW 1978 as amended in 1995 with a view to including WIG craft in the current conventions, albeit, the Guidelines for WIG craft is not mandatory regulations. In this context, IMO actions, current regulations and legal status of WIG craft and problems are discussed in this chapter.

3.2 Review of IMO Actions

The first International Code of Safety for Dynamically Supported Craft was adopted by IMO in 1977. The code provided high-speed craft, mainly hovercraft and hydrofoil boats with safety standards. With a significant progress of technology relating to such kinds of ships since 1977, the necessity for total revision of the code arose.

In the meantime, the initiative in opening discussions about WIG craft was made in 1992 by Russia known as a pioneer country in developing WIG craft⁴⁶ with a proposal about development of the international rules of WIG craft and about insertion of the rules in the new International Code of Safety for High-Speed Craft. In 1993, this initiative was included in the agenda of DE-Sub Committee by Maritime Safety Committee (MSC). By the decision of the MSC, the joint IMO/ICAO group on WIG craft as well as international correspondence group was established.

By reason of fundamental differences of WIG craft from all existing conventional transport means, difficult problems about legal questions, connected with that to which kind of transport a WIG craft should bring aviation or maritime was controversial.⁴⁷ In the meantime, in 1994, IMO adopted new HSC code covering all types of high-speed craft including planning vessels, multihull craft, ground effect ships, and air cushion vehicles only except for WIG craft.

In 2001, amendments to the COLREG 1972 was adopted by the IMO assembly considering the operational peculiarities of WIG craft. In conjunction with the amendments to the COLREG 1972, IMO and ICAO agreed that WIG craft which are able to fly outside the influence of ground effect continuously should be under both jurisdiction of IMO and ICAO, and other craft which are able to fly within the ground effect or limited fly-over should be under IMO jurisdiction only.

⁴⁶ Bogdanov, A. I. (1995). The Problems of Ekranoplans Certification, Conception and Development of IMO Safety Requirements. *In proceedings of International Symposium for Twenty-First Century Flying Ships. (pp. 128-147)*. Sydney : The Institute of Marine Engineers.

⁴⁷ Bogdanov, A. I. (2000). Rules of Classification and Construction of a Type “A” Small Ekranoplans of the Russian Maritime Register of Shipping – a First in the World the Regulatory Document for Civil Ekranoplans. *In proceedings of GEM 2000 International Conference.(pp. 73-80)*. St. Petersburg: Marine Technical University and The Institute of Marine Engineers.

In the long run, as a result of a number of considerations, Interim Guidelines for Wing-In-Ground (WIG) Craft was approved and issued as MSC/Circ.1054 in 2002. Additionally, General Principles and Recommendations for Knowledge, Skills, and Training for Officers on Wing-In-Ground (WIG) Craft Operating in Both Displacement and Ground Effect Modes was endorsed and circulated by MSC in 2005.

3.3 The Current International Regulation on WIG Craft

3.3.1 Legal Status of WIG Craft

Although it was decided that the WIG craft is a vehicle of marine transportation, it has still been a controversial issue whose jurisdiction should be applied to WIG craft, aviation or marine vehicles. To draw a clear line, it is necessary to refer to the legal definition of aircraft.⁴⁸ According to Rules of the Air⁴⁹ by ICAO, definition of Air Craft is as follows.

“Air Craft - Any machine that can derive support in the atmosphere from the reactions of the air, other than reactions of the air against the earth’s surface.”

The WIG craft usually flies by exploiting the ground effect, which is a phenomenon of increasing lift force and reduction of inductive resistance by reactions of the air against the earth’s surface or a surface of water. Thus, as it follows from this definition, the WIG craft does not come within *Air Craft* defined by ICAO. On the contrary, the Interim Guidelines define the WIG craft as follows.⁵⁰

“WIG craft” is a multimodal craft which, in its main operational mode, flies by using ground effect above the water or some other surface, without constant contact

⁴⁸ Bogdanov, A. I. (1995). *supra* note 46.

⁴⁹ International Civil Aviation Organization. (1996). *Rules of the Air 13th Edition*.

with such a surface and supported in the air, mainly, by an aerodynamic lift generated on a wing (wings), hull, or their parts, which are intended to utilize the ground effect action.”

After all, it is clear the difference between aircraft and WIG craft is on the basis of the definitions of IMO and ICAO. Nevertheless, as can be seen from Chapter 2, a WIG craft which can fly outside the influence of the ground effect can be regarded as *WIG craft* by the Interim Guidelines for WIG craft as well as *Air Craft* by the Rules of the Air by ICAO. Indeed, it is quite ambiguous, vexatious and complex problems particularly Type “B” and “C” of the WIG craft which are capable of limited fly-over or operation outside of the ground effect.

In the meantime, according to Bogdanov (1995)⁵¹ and Rules of the Air⁵², the minimum safe altitudes for aircraft are 150, 300 or 600 meters depending on flight conditions. In connection with the legal status of WIG craft, the minimum safe altitude for aircraft became a yardstick to decide which WIG craft falls under ICAO regulatory regime.

On the whole, IMO and ICAO have decided that the WIG craft which is able to fly outside the influence of the ground effect continuously, should fall under both regulatory regimes of IMO and ICAO and the other WIG craft including those with fly-over capability within a limited period under the condition that the maximum altitude is not exceed the minimal safe altitude for an aircraft prescribed by ICAO, i.e. 150 meters, should fall within only by IMO.⁵³

⁵⁰ IMO. (2002). *supra* note 41.

⁵¹ Bogdanov, A. I. (1995). *supra* note 46.

⁵² International Civil Aviation Organization. (1996). *supra* note 49.

⁵³ IMO. (2002). *supra* note 41.

Distinctively, operational modes of WIG craft differ with conventional ships or high speed craft. According to the Interim Guidelines, there are eight operational modes of WIG craft, i.e. amphibian mode, displacement mode, transitional mode, planing mode, take off/landing mode, ground effect mode, fly-over mode and aircraft mode. From Table 3.1 it shows the fields of competency of IMO and ICAO for each operational mode and type of WIG craft as to the legal status of WIG craft.

Table 3.1 - The Fields of Competency of IMO and ICAO

Operational Modes	WIG Craft Types		
	A	B	C
	Competency		
Amphibian Mode	IMO	IMO	IMO/ICAO
Displacement Mode	IMO	IMO	
Transitional Mode	IMO	IMO	
Planing Mode	IMO	IMO	
Take Off / Landing Mode	IMO	IMO	
Ground Effect Mode	IMO	IMO	
Fly-Over Mode (Limited)	-	IMO/ICAO ⁵⁴	
Aircraft Mode	-	-	ICAO

(Note: Type A or Type B of WIG craft including those with limited “fly-over” capability should be covered only by the maritime regulatory regime.⁵⁵ Type C of WIG craft and its operations are not applicable to the Interim Guideline for WIG craft.⁵⁶)

⁵⁴ MSC 77/21/1

⁵⁵ IMO (2002) *supra* note 50 at Article 3 in Preamble.

⁵⁶ *Ibid.* Article 3.4 of Part A.

3.3.2 Interim Guidelines for Wing-In-Ground (WIG) Craft⁵⁷

Interim Guidelines for Wing-In-Ground (WIG) Craft was approved in 2002, at the 76th session of the Maritime Safety Committee. The Guidelines are intended to contribute as much guidance as possible to those involved in the design, construction and operation of WIG craft. The Guidelines consist of three parts, i.e. Part A provides general information, Part B includes provisions that may be subordinate to measure development through the safety assessment, and Part C details the safety assessment. Much of the guidelines include relevant recommendations modified from the 2000 HSC Code.

The Interim Guidelines apply only to type “A” and “B” of the WIG crafts. Type “C” craft, defined as aircraft should comply with all relevant ICAO requirements. Therefore, all WIG craft except type “C” of the WIG craft are recommended to comply with the Interim Guidelines.

According to the Interim Guidelines, all WIG craft except type “C” have to obtain the WIG craft Safety Certificate as well as the Permit to Operate WIG craft before they enter operation. The Safety Certificate certifies that the WIG craft relating to the structure, safety equipment, radio installation and other equipment, fittings and materials have been surveyed and comply with all relevant safety regulations. In addition, in the Permit to Operate WIG Craft, category of craft, name of operator, areas or routes of operation, base port, maximum distance from place of refuge, number of passenger and crew, worst intended conditions and operational restrictions are documented and confirmed by the Administration. What is more, it is recommended that the ISM Code be applied to WIG craft in order to implement a Safety Management System and to maintain safety standards of WIG craft.

⁵⁷*Ibid.*

It might be said that the most significant in the Guidelines is to establish a system for WIG craft. Namely, minimum safety standard, survey, and safety assessment and management for WIG craft are recommended. Like the 2000 HSC Code, the Interim Guidelines have been developed on a flexible risk management basis because it is practically impossible for WIG craft to apply strict prescriptive standards.

However, as the title implies, the Guidelines are neither any mandatory conventions, nor any compulsory code. It is only interim recommendations whether they are observed or not. It is obviously clear that the Guidelines for WIG craft should be mandatory in order to unify minimum safety standards more effectively resulting in creating reliable safety as well as stimulating commercialization of WIG craft. On top of that, although type C of the WIG craft, which is inapplicable to the Interim Guidelines for the WIG craft, should entirely follow the ICAO regime. The problem is that there is no clear regulations governing the operation modes of type C of the WIG craft.

3.3.3 Revised COLREG 1972⁵⁸

The amendments to the IMO Convention on the International Regulations for Preventing Collisions at Sea, 1972 (COLREG) was adopted in November 2001 and entered into force on 29 November 2003. Although the Interim Guidelines for WIG craft are just a recommendation, IMO has legally recognized WIG craft in the amended COLREG.⁵⁹

Taking into account the operational characteristics of the WIG craft, which is capable of flying and floating, the amendments to the COLREG provide rules for collision avoidance for WIG craft as conventional ships. To be more precise, the revised

⁵⁸ IMO.(2001). *The Amendments to the International Regulations for Preventing Collisions at Sea, 1972 as amended.*

⁵⁹ IMO acknowledges WIG craft in amended regulations. *Ship and Boat International*, January/February 2004, pp.39.

COLREG prescribes a definition of the WIG craft and imposes a duty upon the WIG craft, like any other vessels, to install some lights and take action to avoid collision in a defined manner.

As shown in Table 3.1, only aircraft mode that a WIG craft of Type “C” flies above the minimal safe altitude prescribed by ICAO regulations is not applicable to the revised COLREG regulations. This aircraft mode of a WIG craft of type “C” is covered only by ICAO regulations. Surely, all of the other operational modes are under the revised COLREG regulations.

3.3.4 STCW Recommendations on WIG Craft

General Principles and Recommendations for Knowledge, Skills and Training for Officers on Wing-In-Ground (WIG) Craft Operating in Both Displacement and Ground Effect Modes⁶⁰ made by the Sub-Committee on Standards of Training and Watchkeeping at its thirty-sixth session in 2005 were endorsed by the Maritime Safety Committee in 2005. In general, IMO conventions extend over two areas⁶¹: Design, construction and certification, and; operation and licensing. The former area for WIG craft is covered by the Interim Guidelines and the latter area is covered by the amended COLREG and the Recommendations for Officers on WIG craft.

Basically, the recommendations acknowledge a qualification attained under either the international maritime or aviation qualification system because of the characteristics of the WIG craft combining ship and aircraft features. Precisely, both the STCW

⁶⁰ IMO. (2005). *General Principles and Recommendations for Knowledge, Skills and Training for Officers on Wing-In-Ground (WIG) Craft Operating in Both Displacement and Ground Effect Modes*.

⁶¹ Armstrong, N.A. (1995). On the Safety of Navigation Above the Sea. *In proceedings of International Symposium for Twenty-First Century Flying Ships*.(pp.119-127). Sydney: The Institute of Marine Engineers.

certificates as a maritime base qualification certificate and the ICAO certificates listed in the Chicago Convention on International Civil Aviation (1944) as an aviation base qualification certificate are recognized for officers on WIG craft.

Added to these qualifications, officers on a WIG craft should assume training and have proved their additional knowledge and skills sufficiently in line with the recommendations. On condition that these additional qualifications are performed successfully, a special qualification certificate should be issued by the Administration.

Apart from this, the WIG craft can be divided into three types by maximum take-off weight (displacement), i.e. small (up to 10 tonnes), medium (from 10 tonnes up to 500 tonnes) and large (more than 500 tonnes) by the Recommendations. General requirements for a special qualification for types “A” and “B” medium size WIG craft are given in the Recommendations. However, the corresponding requirements for small and large WIG craft have not yet been developed.

3.4 Prescriptive Regulations vs. Safety Case Approach

Traditionally, the regulatory system in the maritime legislation has been quite prescriptive. It is well known that based on empirical knowledge and reaction to accidents and casualties, IMO conventions have been established and amended. More than that, it is able to generalize about regulations for conventional ships on the grounds that the conventional ship has been evolved through large-scale application or extensive scientific research.⁶²

⁶² Papakirillou, A., & Papanikolaou, A. (2001, May). Revisions to the High Speed Craft Code. *The Motor Ship*, pp.56-59.

However, it can be seen that the prescriptive regulations are no longer calculated for the modern innovative ship, which has its own technical and operational peculiarities. To make matters worse, the prescriptive regulations can interfere with development of novel technology of new types of transportation such as WIG craft as well as commercialization of such kind of vessel due to unreasonable cost caused by impracticable prescriptive regulations. Pertaining to this matter, the Australian Maritime Safety Authority (AMSA) says that:

“The rules should be performed based in as much as the application of new technology or design is not inhibited by regulation (subject to an adequate level of safety being achieved).”⁶³

In this context, one of the alternatives, known as the “Safety Case Approach” can be considered appropriate. The Safety Case Approach is the systematic management of risk, consisting of four principal elements, i.e. a core of prescriptive requirements, safety assessment, operational requirements from the safety assessment, and a safety management system. Bishop and Broomfield define the Safety Case as:

“a documented body of evidence that provide a convincing and valid argument that a system is adequately safe for a given application in a given environment.”⁶⁴

It may be said that the traditional prescriptive approach is the top down approach because a vessel should be made complying with the regulations after the regulations are established and approved, whereas, the Safety Case is a bottom up approach⁶⁵ by reason

⁶³ Mayer, L. (1996). Navigation & Safe Operation of Very Fast Craft – The Need For a Safety Case? *In proceedings of Ekranoplans and Very Fast Craft. (pp. 194 -212)*. Sydney: The University of New South Wales.

⁶⁴ Bishop, P. G., & Broomfield, R. E. (1995). The SHIP Safety Case Approach. *In proceedings of SafeCom95 (pp. 437-451)*. Belgirate, Italy : EU Environment Programme.

⁶⁵ Mayer, L. (1996). *supra* note 63.

that this approach can provide designers, builders and operators with solutions to problems through the systematic risk management procedure without introducing any new regulations followed by unique features of the new type of craft and development of technology.

As a matter of fact, the Safety Case approach imposes all of the responsibilities directly on the stakeholders, namely the owner, designer, builder and operator. However, it also gives the freedom to develop novel methods and technology to solve design, construction and operational problems.⁶⁶

The Safety Case is virtually not a new approach. It has already been applied successfully to many other offshore industries such as oil and gas industries, civil aviation and nuclear power industries.⁶⁷ In the maritime field, this approach has already been introduced to the High Speed Craft Code as a concept of equivalence level of safety. The HSC Code contains collection of prescriptive regulations as well as a systematic risk based management procedure. The HSC Code provides that use of Probability Concepts and Procedure for Failure Mode Effect Analysis, which is a basic element of the Safety Case, should be used when an equivalence arrangement is under examination. Through these procedures, an equivalence level of safety can be admitted by the Administration.

As far as the WIG craft is concerned, although it has been classified as a kind of ship, a great deal of physical, technological and operational characteristics of the WIG craft is analogous to those of aircraft. Besides, there is a fundamental difference between the maritime and aviation legislation. For the most part, supposing that emergency situations will happen such as fire, collision or mechanical trouble, a ship is required to be prepared with abundant means for identifiable emergency situations. On the other hand,

⁶⁶ Rozhdestvensky, K.V., & Mikhailov, M.A. (1998). *supra* note 45.

⁶⁷ Mayer, L. (1996). *supra* note 63.

an aircraft, assumes that emergency situations will not happen by virtue of higher safety standards of design, building, inspection and maintenance. In this context, it seems that the strict application of the traditional prescriptive approach of maritime legislation to the WIG craft is unreasonable, but rather the Safety Case Approach is appropriate.

Like the HSC Code, the Interim Guidelines for WIG craft follow the flexible risk management, viz., the Safety Case Approach. The Guidelines say that

“The basis for the Interim Guidelines is flexible risk management. Although this is a paradigm shift from the prescriptive standards forming the basis of the 2000 HSC Code, the intention is to achieve safety standards comparable to those of the 1974 SOLAS Convention.”⁶⁸

The Interim Guidelines place emphasis on the safety assessment process that may provide WIG craft with risk control measures. Although prescriptive recommendations related to the craft system which is generally accepted risk control measures are provided in the Interim Guidelines; risk control measures developed through the safety assessment process may override the prescriptive recommendations.

To sum up, it is believed that although the Interim Guidelines are not mandatory regulations, the direction in current guidelines to the Safety Case is a way to the right regulatory regime approach. For the WIG craft which is very fast and new, practically unproven type of marine vehicle, the Safety Case Approach is adequate to confirm the safety, to stimulate innovative technology and to promote commercial operation of WIG craft.

⁶⁸ IMO. (2002). *supra* note 41.

3.5 Conclusions

To conclude, international legislation on WIG craft is absolutely necessary to commercialize WIG craft in terms of safety as well as certification issues. By virtue of IMO's effort to make international regulations on WIG craft, the Interim Guidelines for WIG craft, COLREG 1972 and STCW recommendations on WIG craft have been adopted or amended. However, there are some problems associated with the international legislation on WIG craft.

Firstly, the Interim Guidelines are not mandatory regulations. It can be said that if regulations are not enforced, they become irrelevant; therefore, the Guidelines should be a mandatory code in order to maintain relevance and unify standards resulting in encouraging commercialization of WIG craft.

Secondly, in view of the Guidelines which are not applicable to type "C" of the WIG craft, it is quite unclear on regulations for type "C" of the WIG craft, albeit, it should follow ICAO regulations. On the ground that type "C" WIG craft also has the same operational mode as the other WIG craft except aircraft mode, it is required that regulations for type "C" of the WIG craft be enacted as the others.

Thirdly, mandatory STCW regulations for officers on WIG craft should also be made. Moreover, requirements for small and large WIG craft should be developed.

Last but not least, the safety case approach for WIG craft is certainly in order likewise civil aviation industry; therefore, it should still be maintained in a mandatory code.

CHAPTER FOUR

ECONOMIC REASONABLENESS OF WIG CRAFT

4.1 Comparative Analysis

4.1.1 Karman-Gabrielli Diagram

It goes without saying that when a new type of transportation is introduced, cost-effective analysis should be carried out whether it has economic reasonableness. In connection with this matter, the first researchers to theorize comparative cost-effective studies of specific power required for propulsion of vehicles were well-known Gabrielli and von Karman (1950).⁶⁹ In fact, this method is a classical method to analyze the efficiency of a transport medium. According to Gabrielli and von Karman, specific resistance is defined as the maximum installed power divided by the product gross weight multiplied by its velocity, i.e.

$$\varepsilon = \frac{P}{W \cdot V} \tag{4.1}$$

where, P = power in unit of ib-ft/s,

W = weight in ib,

⁶⁹ Gabrielli, G., & von Karman, TH. (1950, October). What Price Speed? *Mechanical Engineering*, 72 (10), pp. 775-781.

V = speed in ft/s.

As can be seen from Figure 4.1, which is one of the original typical diagrams of Gabrielli and Karman, it shows that specific resistance of various types of locomotion.

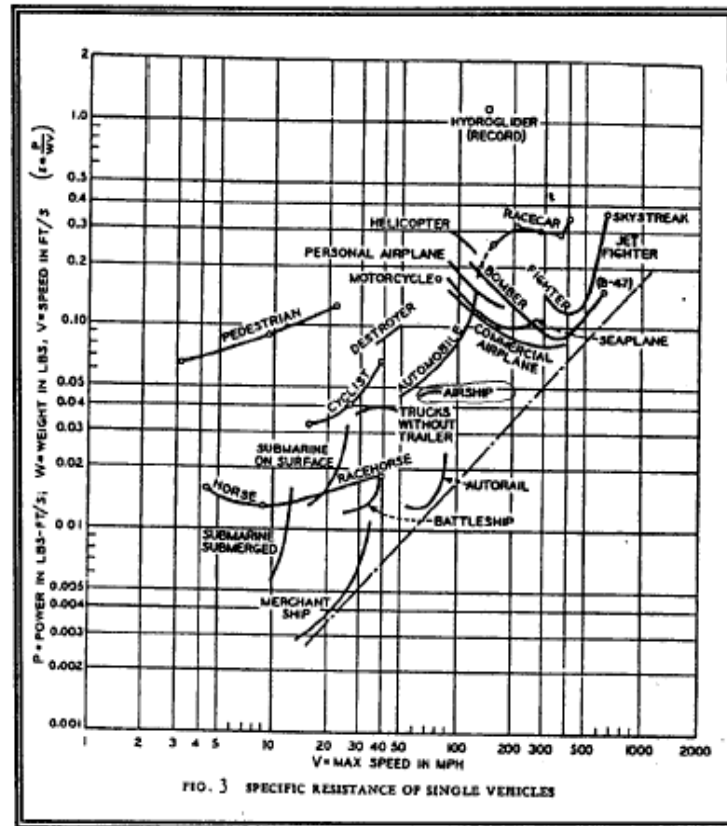

Figure 4.1 - Specific Resistance of Single Vehicles

(Source: Gabrielli and Karman (1950))⁷⁰

The centerline means the state-of-art technology to achieve a certain speed with a desired payload at a minimum power. Obviously, the closer the specific resistance of locomotion to the centerline, the higher the efficiency of one is. For example, the

⁷⁰ *Ibid.*

specific resistance of the helicopter is larger than that of the commercial airplane. Surely, it means the efficiency of the commercial airplane is higher than that of the helicopter. In addition, it shows a wide range of specific resistance between various types of vehicles.⁷¹ Hence, it can be noteworthy that the specific resistance of the WIG craft is located between the merchant ship and commercial airplane. That is to say, WIG craft have a potential to fill the gap between ships and aircraft.

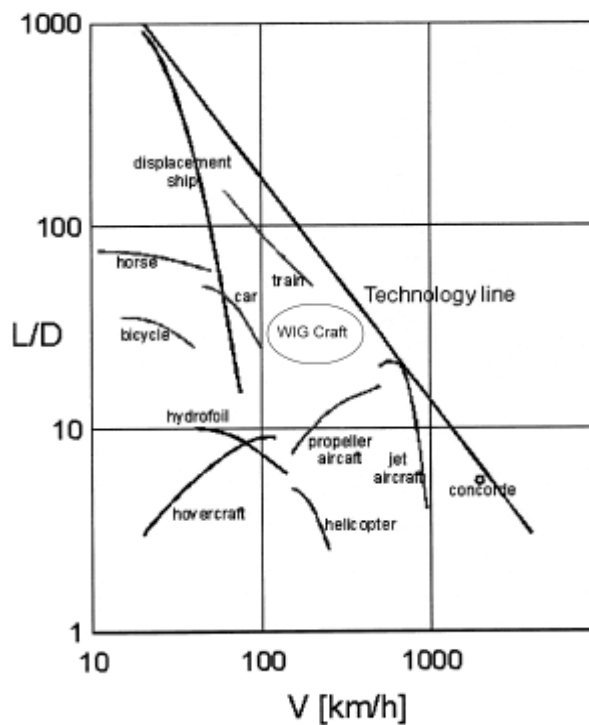

Figure 4.2 - Lift-to-Drag Ratio for Different Locomotion

(Source: Halloran and O'Meara (1999))

Figure 4.2, taken from Halloran and O'Meara (1999)⁷² shows that an updated version of

⁷¹ Alexander, H. D., & Lawrence, J. D. (2002). A Study of the Efficiency of the Wing-In-Ground-Effect Concept. *In proceedings of international Conference on Twenty-First Century Flying Ships. (pp.1 -21)*. Sydney : The Institute of Marine Engineers.

⁷² Halloran, M., & O'Meara, S. (1999). *supra* note 14.

this data, which is the inverse of the specific resistance and is simply the lift - drag ratio of locomotion. As a rule, the two diagrams, Figures 4.1 and 4.2 are in essence the same.

In addition, Karman-Gabrielli Diagram can be modified in various ways. Figure 4.3 is one of the modifications from the Karman-Gabrielli Diagram. It shows required power for different transport modes. As might be expected the WIG craft shows greater efficiency as compared with that of the others.

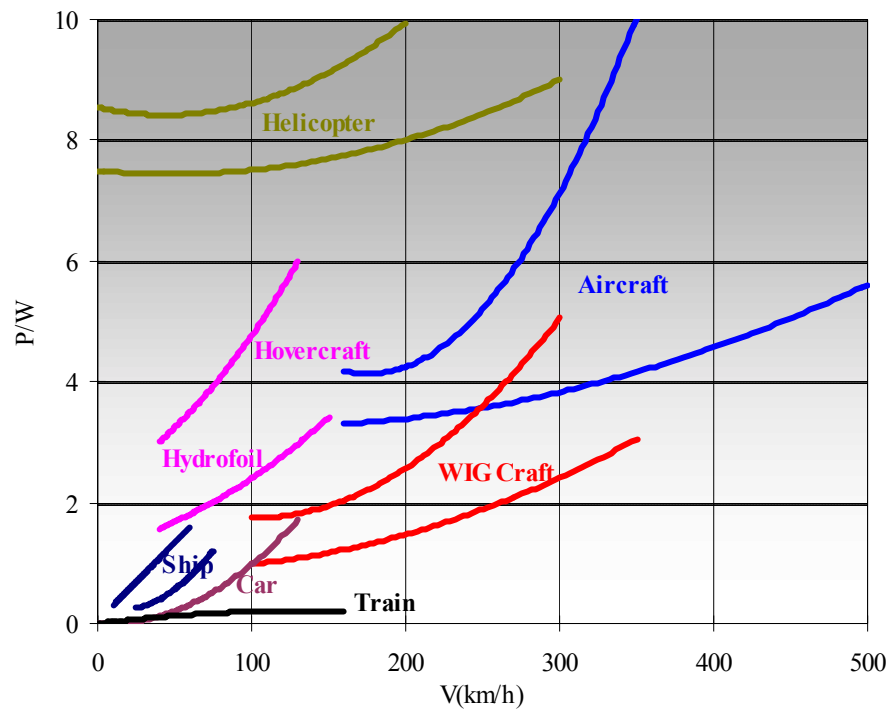

Figure 4.3 - Required Power for Different Transport Vehicles

(Source: Greene (1997))⁷³

⁷³ Greene, W. J. (1997). *supra* note 11. .

4.1.2 Transport Productivity

4.1.2.1 Payload Ratio

It may be said that payload ratio is a matter of importance for understanding the economic efficiency of WIG craft. Payload ratio means the ratio of the payload to the full weight of the vehicle. As can be seen from Figure 4.4, the payload weight fraction (W_p/W) of ships is higher than that of WIG craft and aircraft. On the contrary, the speed of ships is comparatively lower than that of the others. Indeed, the payload ratio of WIG craft is analogous to that of aircraft.

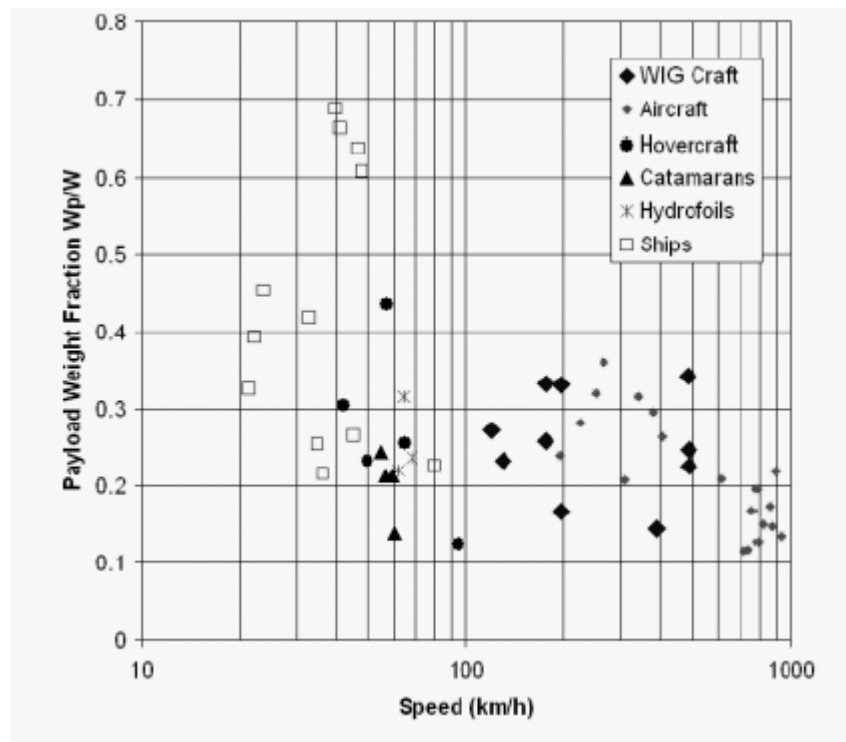

Figure 4.4 - Payload Ratio versus Speed

(Source: Halloran, M. & O'Meara, S. (1999))⁷⁴

⁷⁴ Halloran, M., & O'Meara, S. *supra* note 14.

4.1.2.2 Transport Productivity of High Speed Marine Vehicles

In conjunction with the payload ratio, although the payload ratio of some vehicles is high, their speed is quite low such as on ships, while the other payload ratio of some vehicles is comparatively low; however, their speed is considerably high such as on WIG craft and airplanes. Definitely, aside from the payload ratio, the speed of vehicles is also an important economic parameter. From that point of view, another useful measure is transport productivity, i.e. the payload ratio times speed, can be used in order to demonstrate economic efficiency of vehicles.

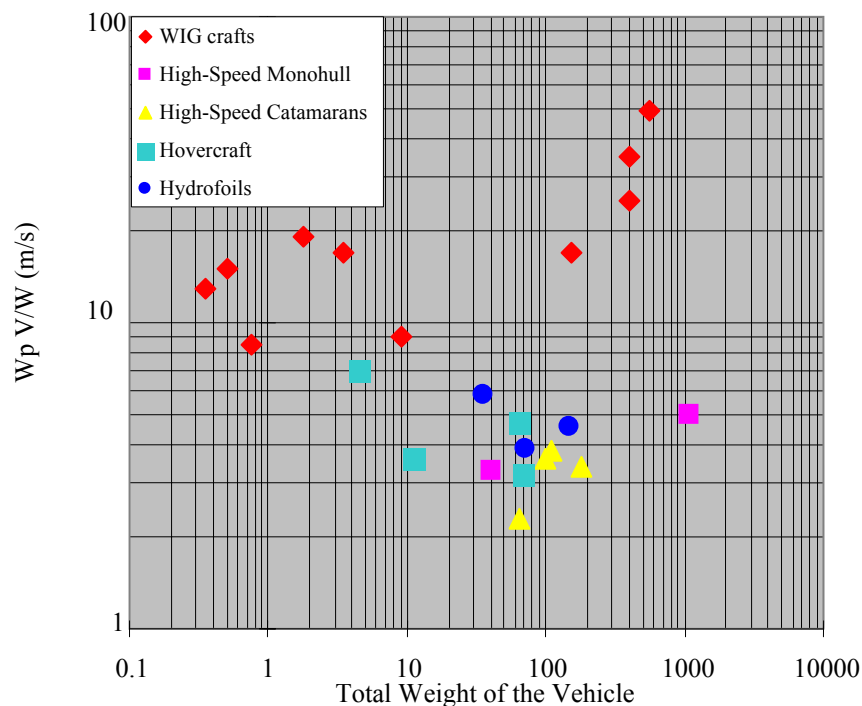

Figure 4.5 - Transport Productivity of High-Speed Marine Vehicles

(Source: Rozhdestvensky (1995))⁷⁵

⁷⁵ Rozhdestvensky, K.V. (1995). Ekranoplans – Flying Ships of the Next Century. *In proceedings of International Symposium for Twenty-First Century Flying Ships*. (pp. 47-70). Sydney: The Institute of Marine Engineers.

From Figure 4.5, it can be clearly seen that the transport productivity of WIG craft is beyond all comparison with the other high-speed marine vehicles. Obviously, WIG craft have an advantage over the whole range of weight of the other vehicles. Hence, this figure can justify the advent of WIG craft as new innovative transportation.

4.1.2.3 Fuel Consumption vs. Total Weight

Fuel consumption is another important characteristic of vehicles. Table 4.1 shows fuel consumption efficiency of several aircraft and WIG craft (MPE-200). Although Q_{pass} and Q_t load of a WIG craft that is the Russian Ekranoplan MPE-200, are comparatively high, the Q_t weight of WIG craft is quite competitive with the modern civil aircraft. It can be inferred from the table that weight efficiency of the WIG craft is lower than that of current air craft due to the required power for take-off and equipment for safety in sea operations.

Table 4.1 - Comparison of Fuel Efficiency

(Source: *Sinitsyn, D., and Maskalik, A. (1996)*)⁷⁶

Type of a Vehicle	Q_{pass}	Q_t load	Q_t weight
Boeing 707-320C	31.3	334	8.54
Aerobus A 310-300	33.9	339	4.98
Aerobus A 300 B4	34.0	329	8.54
WIG craft(MPE-200)	47.0	466	7.71

where,

Q_{pass} = gram of fuel / 1 passenger 1 km (fuel consumption in order 1 passenger x 1 km)

Q_t load = gram of fuel / 1t of load 1 km (fuel consumption in order 1t of load x 1 km)

⁷⁶ Sinitsyn, D., & Maskalik, A. (1996). *supra* note 4.

Qt weight=liters of fuel / 1t of weight 100 km (fuel consumption in order 1t of total weight x 100 km)

Further, Figure 4.6 shows that fuel consumption of WIG craft is competitive on the whole.

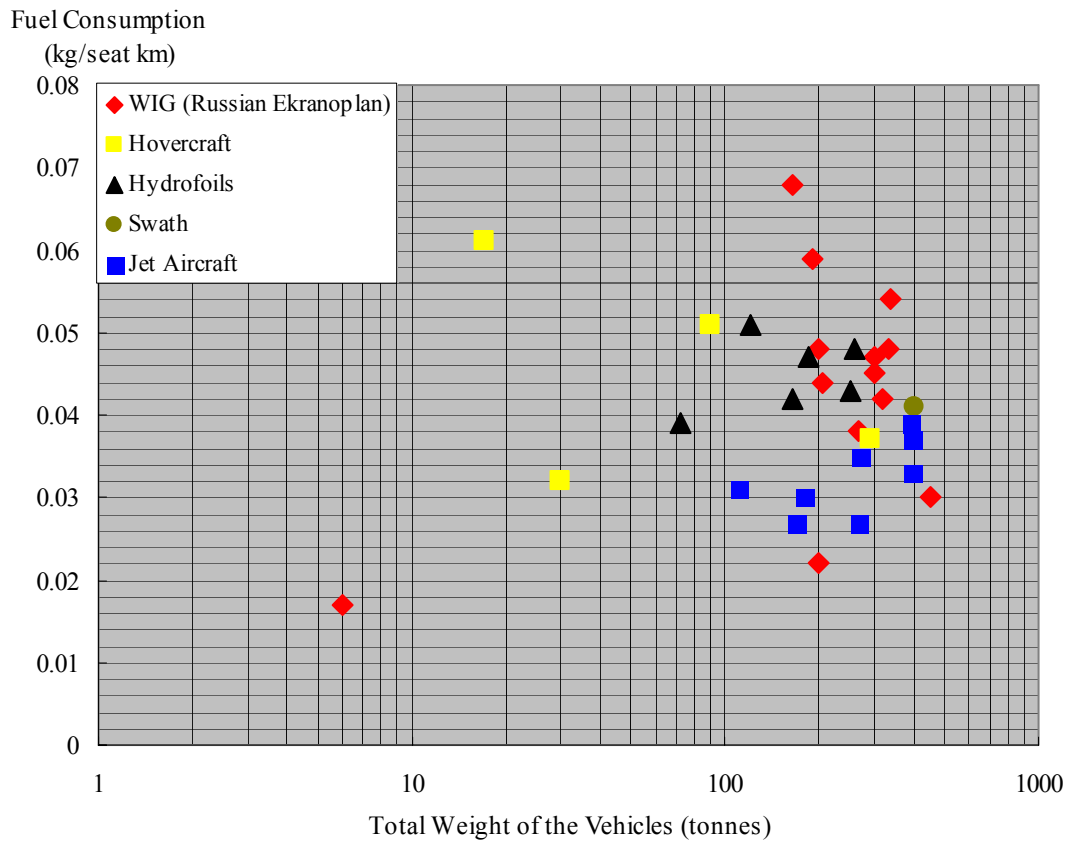

Figure 4.6 - Fuel Consumption of High-Speed Marine Vehicles vs. Total Weight
(Source: Rozhdestvensky (1995))⁷⁷

However, the level of fuel consumption of WIG craft is not up to scratch, the reason of which is that not only the WIG craft are not commercial purpose vehicles on the ground

⁷⁷ Rozhdestvensky, K.V. (1995). *supra* note 75.

that the Russian Ekranoplan was developed for military purposes but also fuel consumption efficiency of WIG craft needs to be more improved.

4.1.3 Transport Effectiveness

To evaluate of the payload and passenger capacity of WIG craft compared with other modes of transportation, transport effectiveness can be used as follows:

$$TE = \frac{W_p \cdot V}{N} = K_\eta \cdot \frac{W_p}{W_0} \quad (4.2)$$

where,

W_0 – full weight (displacement)

W_p – the required payload

V – cruising velocity

N – full power of all motors

K_η – coefficient of propulsive quality

$$K_\eta = \frac{W_0 \cdot V}{N} \quad (4.3)$$

Furthermore, to be more precise, based on useful payload, the transport effectiveness can be expressed as follows:

$$TE_{ful} = \frac{W_{us} \cdot V}{N} = K_\eta \cdot \frac{W_{us}}{W_0} \quad (4.4)$$

where,

W_{us} – useful payload

In addition, WIG craft are required extra power for take-off. This extra power is not used fully when the vehicle is on a cruise. From this standpoint, transport effectiveness for propulsive engine power can be expressed as follows:

$$TE_{ex} = \frac{W_p \cdot V}{N_{ex}} = K_{\eta.ex} \cdot \frac{W_p}{W_0} \quad (4.5)$$

where,

N_{ex} – the propulsive power, using at the velocity V

$K_{\eta.ex}$ –coefficient of propulsive quality, calculated on the propulsive power

Next, based on useful payload and propulsive engine power, transport effectiveness can be represented as follows.

$$TE_{ful.ex} = \frac{W_{us} \cdot V}{N_{ex}} = K_{\eta.ex} \cdot \frac{W_{us}}{W_0} \quad (4.6)$$

In addition, fuel expenditure, based on passenger kilometer, can be declared as follows:

$$QKR = \frac{C_e \cdot N_{ex}}{V \cdot n_{pass}} \quad (4.7)$$

where,

C_e – relative fuel expenditure (kg/ (kw x hour))

n_{pass} – number of passenger

In accordance with the above equation, the values are calculated as follows:⁷⁸

Table 4.2 - Transport Effectiveness

Transport Type	TE	TE_{ful}	TE_{ex}	$TE_{ful,ex}$	QKR
Semi-displacement ships	1.6-2.6	2.0-2.9	1.8-2.9	2.2-3.2	0.022-0.036
Catamarans	1.0-1.8	1.2-2.2	1.1-2.0	1.3-2.4	0.033-0.060
SES	1.6-3.2	2.0-4.0	1.8-3.5	2.2-4.4	0.023-0.045
ACS	0.6-1.5	0.7-2.0	0.7-1.7	0.8-2.2	0.050-0.100
Hydrofoils	1.0-1.5	1.2-1.7	1.1-1.7	1.3-2.9	0.040-0.065
WIG Crafts	1.5-2.9	2.0-4.0	1.9-3.9	2.9-5.8	0.022-0.049
Aircrafts	1.0-2.0	1.5-4.0	2.0-4.0	3.0-8.0	0.020-0.040

As can be seen from Table 4.2, not only transport effectiveness of the WIG craft is obviously higher than other marine vehicles but also it is nearly the equal of that of aircraft.

4.1.4 Transport Factor

Another useful tool for the evaluation of economic efficiency of WIG craft is the so-called “*Transport Factor*” introduced by Kennell.⁷⁹ According to Kennell, the Transport Factor is expressed as follows:

$$TF = \frac{K_2 \cdot W}{SHP_{TI} / (K_1 \cdot V_K)} \quad (4.8)$$

⁷⁸ Basin, M. (1997). WIG (Ecranoplane) as a Transport Vessel and Sport Craft. *In proceedings of International Symposium and Seminar for the Safety of High Speed Craft. (pp. 1-12)*. London : The Royal Institution of Naval Architects.

⁷⁹ Kennell, C. (1998). *Design Trends in High-Speed Transport*. Journal Marine Technology, Vol. 35, No.3.

where,

W – displacement of vessel

SHP_{TI} – total installed power

V_K – design speed in knot

K_1 – constant (1.6878/550 HP/lb-kn)

K_2 – constant (2240 lb/LT)

Figure 4.7 presents Kennel's Transport Factor vs. speed.

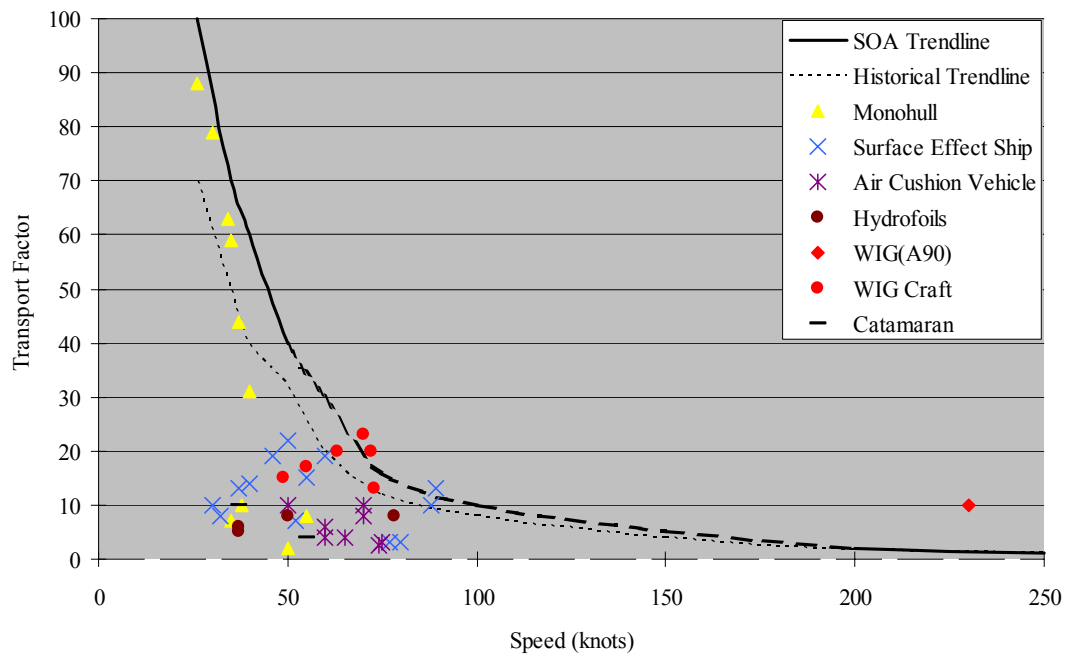

Figure 4.7 - Vehicle Transport Factor

(Source: Kennel (1998))⁸⁰

According to Kennel, Transport Factor is decomposed into three as follows.

$$W = W_{ship} + W_{cargo} + W_{fuel} \quad (4.9)$$

where,

W_{ship} – displacement of light ship

W_{cargo} – displacement of cargo

W_{fuel} – displacement of fuel

$$TF = TF_{ship} + TF_{cargo} + TF_{fuel} \quad (4.10)$$

where,

TF_{ship} , TF_{cargo} , TF_{fuel} – Transport Factors calculated for each weight group

Figure 4.8 illustrates transport factors relating to fuel efficiency of transportation by Kennell.

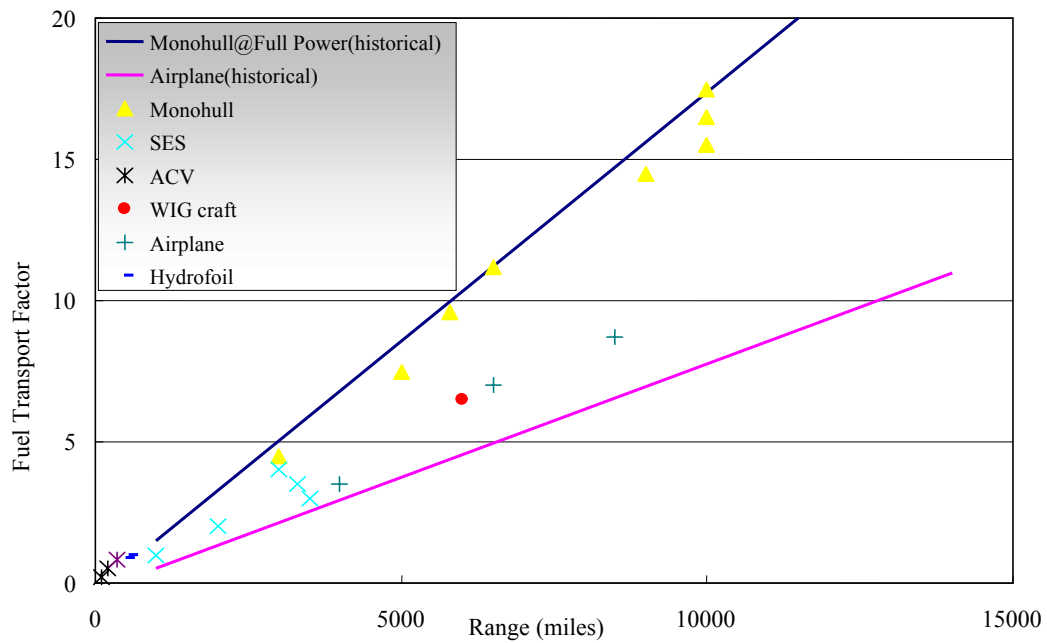

Figure 4.8 - Fuel Transport Factor

(Source: Kennell (1998))⁸¹

⁸⁰ Ibid.

⁸¹ Ibid.

As can be seen from Figures 4.7 and 4.8, the transport factor of WIG craft is clearly competitive with fast marine vehicles as well as quite comparable with aircraft. Another point is that size and speed of craft directly affect the transport factor in a positive way. Hence, size and speed of WIG craft are key elements to improve the transport factor.

4.2 Cost Analysis of Modeled Routes

4.2.1 Introduction

Hitherto, general economic efficiencies on WIG craft have been analyzed. To begin with, in order for WIG craft to be successful in commercialization, it goes without saying that the craft price and operation cost should be examined as compared with those of competing means of transportation such as conventional ships and aircraft. Albeit, Hooker⁸² ambitiously maintains the beneficial factors and the need for developing full scale WIG craft as a mega transport concept competing with conventional container ships. It may be too premature to discuss and analyze detailed operating costs. After all, there is no doubt that the bigger the WIG craft is, the higher the efficiency is. Yet for this reason, it may be difficult to develop and commercialize such kind of full scale WIG craft under the present circumstances. It seems that commercialization of the WIG craft is obviously prone to arise through operation of small-scale craft. In this context, it is desirable that this chapter makes an analysis of the cost of WIG craft operations, carrying passengers and relatively small size, by comparison with that of other existing types of transportation.

4.2.2 Analysis Methodology

4.2.2.1 Assumption

The preceding chapter 4.1 shows that WIG craft put between aircraft and ship in various aspects at large. Hence, the direct operating costs of WIG craft can be assumed is mediated between aircraft and ship. Apart from this, provided that the cost of WIG craft operations is higher than that of aircraft, it could be the case that commercialization of

⁸² Hooker, S. F. (1996). Some Thoughts on the Commercialization of Ekranoplans and Wingships. *In proceedings of Ekranoplans and Very Fast Craft. (pp. 272 - 299)*. Sydney: The University of New South Wales.

WIG craft is unattainable at this stage. For that reason, with a view to commercialization of WIG craft, the cost should be interpolated between aircraft and ship.

As a rule, as far as the price of WIG craft is concerned, it is a knotty problem to be estimated because there is little reliable base of its presumption. For this reason, to begin with, the price of a WIG craft is estimated by Rozhdestvensky and Kubo's formula, which is found on aviation statistics to estimate the price of an aircraft. In the following, the competitive level of the price of WIG craft will be deduced from the calculated DOC.

4.2.2.2 Analysis Framework

According to Amyot et al.⁸³, Total Operating Cost (TOC) consists of direct operating cost (DOC), which is straightly required for operating a craft such as price of a vehicle, maintenance cost, fuel cost and crew cost and indirect operating costs (IOC) that account for secondary items, such as administrative and general costs, facilities and indirect personnel. Hence, it can be expressed as:

$$TOC = DOC + IOC, \quad (4.11)$$

or, Amyot thus simply describes it as⁸⁴ :

$$TOC = DOC (1+K_i), \quad (4.12)$$

where,

the factor K_i is the indirect to direct cost ratio and can be assumed to be range

$$1.5 \leq K_i \leq 2. \quad ^{85}$$

⁸³ Amyot, J. R., (Eds.). (1989). *Hovercraft Technology, Economics and Applications*. Amsterdam: Elsevier Science Publishers B.V.

Akagi, S. (1993). A Study of Transport Economy and Market Research for High Speed Marine Passenger Vehicles. *In proceedings of Fast 93, Second International Conference on Fast Sea Transportation*. (pp. 1129-1142). Yokohama : The Society of Naval Architects of Japan.

Kubo, S. (1993). A Concept of Wing-In-Surface-Effect Craft as a Future Passenger Transport in Japan. *In proceedings of Fast 93, Second International Conference on Fast Sea Transportation*. (pp. 1573-1584). Yokohama: The Society of Naval Architects of Japan.

Hence, it may be said that the estimate of direct operating costs of WIG craft in comparison with aircraft and ships is justified to analyze economic reasonableness on WIG craft. The main components and procedure of analysis of direct operating costs can simply be illustrated in Figure 4.9.⁸⁶

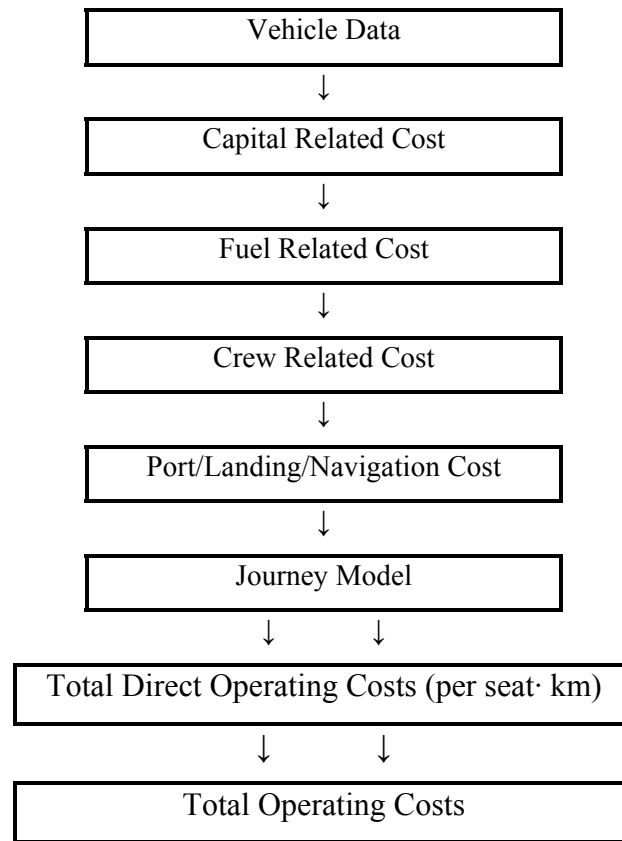

Figure 4.9 - Main components of Operating Costs

⁸⁴ Amyot, J.R. (1989). *supra* note 84.

⁸⁵ Rozhdestvensky, K. & Kubo, S. (1997). A Parametric Analysis of a Flying Wing Configuration in Extreme Ground Effect. *In proceedings of International Symposium and Seminar for the Safety of High Speed Craft.* (pp. 78-96). London : The Royal Institution of Naval Architects.

In practice, it might be true that all costs are variable and depend upon the price elasticity of external economic and market environments, such as changes in oil price and on the way the company gets on the right track.⁸⁷ Hence, granting that operating costs are mutable depending on various cost factors, the purpose of cost analysis of WIG craft in comparison with other craft in this chapter is to study whether the WIG craft is viable to be commercialized.

4.2.3 Estimate of Total Direct Operating Cost

Albeit, various methods of cost analysis have been used to calculate operating costs, Akagi's (1993)⁸⁸ (as cited in Rozhdestvensky and Kubo, 1997)⁸⁹ formula is suited to estimate direct operating costs (per seat · km).

$$DOC = \left[\left\{ \frac{1 - r_v}{A} + r_{ins} + r_{int} \right\} + r_m \right] \cdot \left(\frac{K_s}{N_p \cdot V_s} \right) \cdot \frac{1}{T_a} + \left(\frac{C_{fu} \cdot M_f}{R \cdot N_p} \right) + \left(\frac{S_c \cdot N_c}{N_p \cdot V_s} \right) \cdot \frac{1}{T_a} \quad (4.13)$$

where,

r_v – rate of residual value

A – amortization

r_{ins} – annual rate of insurance

r_{int} – annual rate of interest

r_m – annual rate of maintenance

K_s – price of the vehicle

N_p – number of passenger

⁸⁶ Taylor, G.K. (2000). Wise or Otherwise? The Dream or Reality of Commercial Wing In Ground Effect Vehicles. *In proceedings of GEM 2000 International Conference*. St. Petersburg: Marine Technical University and The Institute of Marine Engineers.

⁸⁷ Stopford, M. (1997). *Maritime Economics*. Abingdon : Routledge.

⁸⁸ Akagi, S. (1993). *supra* note 83.

⁸⁹ Rozhdestvensky, K., & Kubo, S. (1997). *supra* note 86.

V_s – vehicle speed (km/h)
 T_a – annual utilization (in hours)
 C_{fu} – price of fuel per kg, including lubricant
 M_f – mass of the fuel
 R – range (km)
 S_c – average yearly crew cost per person
 N_c – number of crew

Fundamentally, the above cost factors are set to as follows: Rate of residual value (r_v), annual rate of interest (r_{int}), and maintenance cost rate (r_m) of all vehicles are set to 0.1, 0.05 and 0.03 respectively. Amortization year (A) of all craft is set to 14 years and annual rate of insurance (r_{ins}) is set to 0.01 for all craft. The price of fuel is fixed to 0.4 (USD) per kg for all vehicles. Average yearly crew cost per person (S_c) of WIG craft is taken by average value of crew cost per person of aircraft and fast ferries.⁹⁰ The annual utilization time (T_a) has used the following formula taken by Akagi (1993).⁹¹

$$T_a = n_a \cdot \left(\frac{t_d}{t_r + L_R / V_s} \right) \cdot \left(\frac{L_R}{V_s} \right) \quad (4.14)$$

where,

n_a – annual number of operating days
 t_d – number of operating hours per day
 t_r – terminal hours per service
 L_R – length of the route

⁹⁰ Korea Occupational Outlook. (2005), and ITF TCC Wage Scale (2006).

⁹¹ Akagi, S. (1993). *supra* note 83.

The annual number of operating days (n_a) is set to 320 days for all vehicles and the number of operating hours per day (t_d) is set to 12 hours for all craft. The terminal hours per service (t_r) for aircraft, fast ferries and WIG 1&2 and WIG 3 craft fall to 0.5, 0.67, 0.25, and 0.42 respectively.

As mentioned, it can be said that the most prevailing parameter upon DOC *inter alia*, is the price of the vehicle. Because of the difficulty to estimate the price of the WIG craft without any reliable information, it can be considered to use the following formula⁹² originated from aviation statistics.⁹³

$$K_s = 3.7 \cdot 10^5 \cdot 0.8730 \cdot N_p \cdot P(N) \text{ (USD)} \quad (4.15)$$

where,

P(N) – factor of number of built vehicles, if the number of vehicle is sufficiently large, P(N) = 1. In this calculation, P(N) is set to 1.

4.2.4 Modeled Scenario

4.2.4.1 Route

As can be seen from the above Chapters, the WIG craft mediates between aircraft and ship functionally as well as economically. Considering its characteristics and current commercial environment of the WIG craft at the initial stage, it might be desirable that the model route should not be very long distance. In fact, as discussed in Chapter one and two, very long distance transportation by WIG craft is not yet technically proved. For this reason, a route distance of 200 km is suited for the model.

⁹² Rozhdestvensky, K., & Kubo, S. (1997). *supra* note 86.

⁹³ Boeing Information on Cost of the Boeing Jetliners. (June 6, 1996).

4.2.4.2 Vehicle Model

The following vehicle models⁹⁴ are used for the analysis:

WIG 1 - 34 passenger seat, notional specification with power at 1/3rd that of Saab 340

WIG 2 - 50 passenger seat, based on Raketa-2 specification

WIG 3 – 150 passenger seat, based on A.90 ekranoplan specification

Saab 340 aircraft - 34 passenger seats

Saab 2000 aircraft - 50 passenger seats

74m NGA fast passenger ferry - 450 passenger seats

38m Austal catamaran ferry - 430 passenger seats

4.2.4.3 Calculated Results and Analysis

There may be many operational constraints and commercial risks of WIG craft arising from the seaworthiness of WIG craft. What is more, the nominal speed of craft does not correspond with the effective speed particularly in short distance. Such kind of factors not only have an influence on the results of DOC calculation that is calculated without consideration of moderation of cost factors but also may distort the structure of DOC. On the contrary, it may be possible that inaccurate moderation of the cost factor also makes the analysis unreliable. Hence, to avoid possible distortion, both cases should be examined.

Case 1: Direct Operating Costs calculated without moderation of cost factors

Calculated direct operating costs of model vehicles are as follows:⁹⁵ For the sake of examination of the effects of each cost factors to the total DOC, the DOC can be divided into 3 parts, i.e. DOC of capital related (DOC 1), fuel related (DOC 2) and crew related

⁹⁴ See detailed specification of the model vehicles in the appendix A.

⁹⁵ See detailed results and cost factors in the appendix B.

(DOC 3).

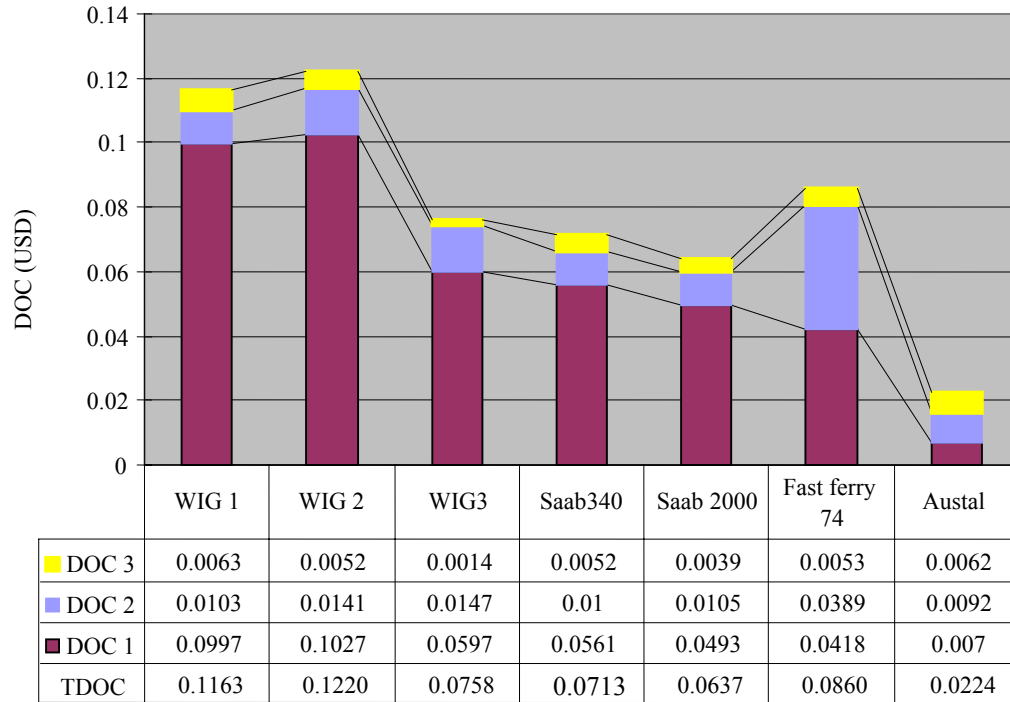

Figure 4.10 - Direct Operating Costs of the Model Vehicles in Case 1

As can be seen from Figure 4.10, direct operating costs of WIG craft are comparatively high due to capital related operating costs. The proportion of capital related cost of each model craft in the total DOC is as follows.

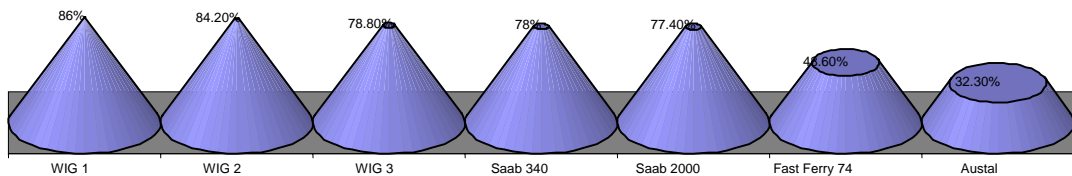

Figure 4.11 - The Proportion of DOC 1 of Model Vehicles

Figure 4.11 shows that capital related costs of WIG craft are higher than those of other craft. Hence, it can be inferred that the price of WIG craft that is calculated by formula 4.15 that estimates the price of WIG craft to be the same price level of aircraft has little competitive power with aircraft in cost. For WIG craft to become commercially successful in economic competition, the price and cost should be competitive. Based on DOC of the above model aircraft, the maximum price of WIG craft, which has the competitive power, can be deduced as follows:

Table 4.3 - Maximum Competitive Price of WIG craft in Case 1

(Unit: USD)

	WIG 1	WIG 2	WIG 3
Initial Price	10,659,330	16,150,500	48,481,500
Maximum Competitive Price	5,846,980 (at DOC of Saab340)	6,979,404 (at DOC of Saab2000)	41,712,949 (at DOC of av.aircraft)

The above maximum competitive price of WIG craft fall to 54.9%, 43.2% and 86.0% of the initial price which are calculated by formula 4.15. Indeed, it can be suggested that the price of WIG craft should not exceed the above maximum price so that WIG craft have the competitive power.

Case 2: Direct Operating Costs calculated by moderation of cost factors

Although amortization year (A) of aircraft and fast ferries are set to 14 years, that of WIG craft is decided to be set to 10 years because not only is there little record for durability of WIG craft but also the operational environment may adversely affect the life span of WIG craft. By the same token, the annual insurance rate (r_{ins}) is set to 0.015 for WIG craft and 0.01 for the other craft.

There may be more operational constraints of WIG craft than those of other craft in particular wave heights. Although it may be possible that WIG craft can be operated at night, it should be verified technically as well as experimentally. However, as of now, it is still doubtful whether commercial WIG craft can be operated at night. Considering these operational constrains, the number of operating hours per day (t_d) is set to 8 hours for WIG craft and 12 hours for other craft. Although journey time depends on nominal vehicle speed, it needs to take times to achieve nominal vehicle speed, such as takeoff, landing, taxing, acceleration, and deceleration. Hence, it is suitable for using effective speed of craft in lieu of nominal vehicle speed to prevent the results from distortion. The results of direct operating costs of WIG craft and the other craft are as follows.⁹⁶

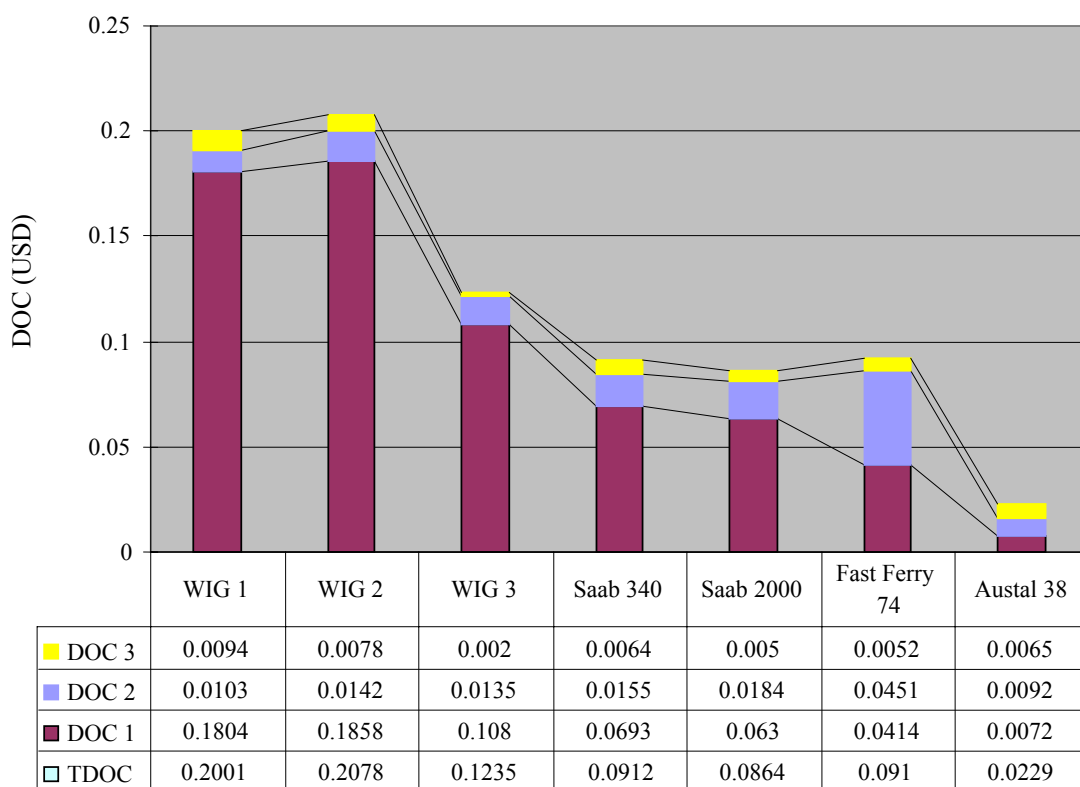

⁹⁶ See detailed results and cost factors in the appendix C.

Figure 4.12 - Direct Operating Costs of Model Vehicles in Case 2

As can be seen in Figure 4.12, direct operating costs of WIG craft are still much higher than those of other craft. It is because the capital related cost (DOC 1), which includes the price of craft has a great influence on the total DOC. Although capital related cost has a great majority of total direct operating costs in most cases, as for WIG craft in both case 1 and case 2, it goes beyond feasibility of commercialization considering competition with aircraft and fast ferries particularly in WIG 1 and WIG 2, which are relatively small size.

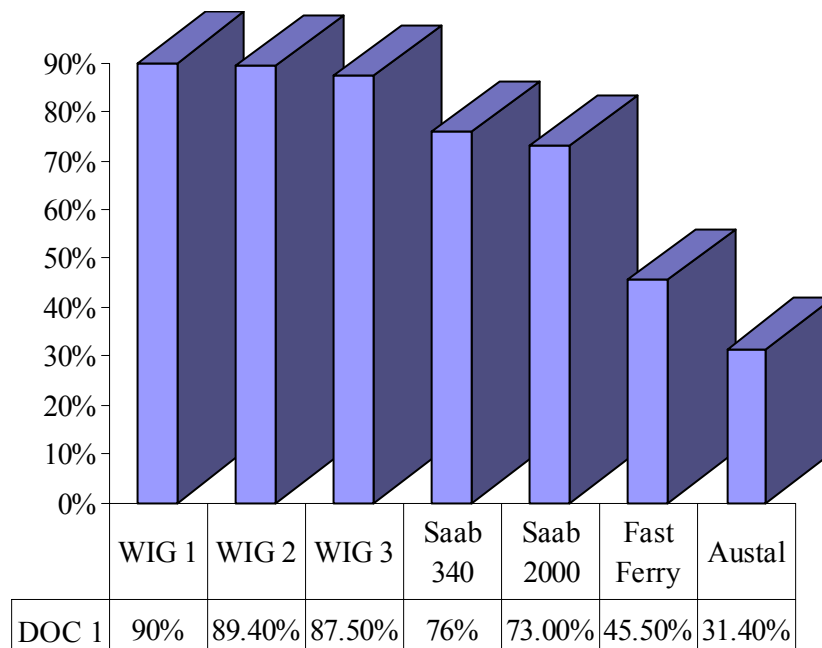

Figure 4.13 - The Percentage of DOC 1 in the Total DOC of Model Craft

From Figure 4.13, it can be seen to be more precise that direct operating costs related to capital cost of WIG 1 and 2 are about 90%, whereas, DOC 1 of aircraft is about 75% and the for fast ferries about 38%.

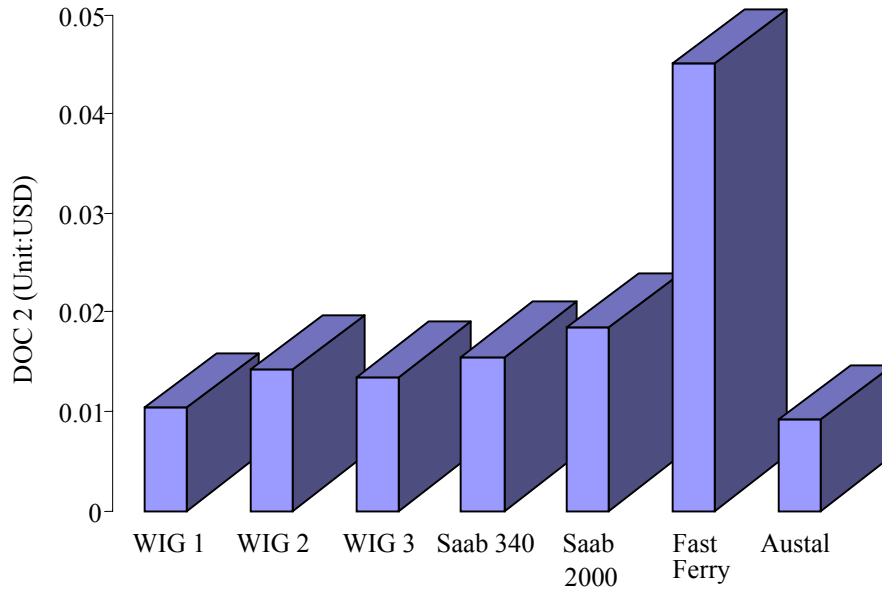

Figure 4.14 - The Fuel Related Costs (DOC 2) of Model Craft

Apart from this, it can be seen from the figure 4.14 that comparative fuel related cost of WIG crafts are not notably lower than those of aircrafts and the total direct operating costs of WIG crafts are only marginally affected by fuel related cost beyond expectation. The reason is that the range is comparatively short, moreover, it seems that the current WIG craft particularly this model, i.e. Raketa-2 and A-90, has need to make the best of wing-in-ground-effect phenomenon so that fuel efficiency can more increase.

Based on DOC of above model aircrafts, the price of WIG crafts that has the competitive power can be deduced as follows. The maximum competitive price of WIG craft deduced from the DOC of the aircrafts accounts for 39.6%, 34.7% and 67.9% of initial price that are calculated by formula 4.15.

Table 4.4 - Maximum Competitive price of WIG craft in Case 2

(Unit: USD)

	WIG 1	WIG 2	WIG 3
Initial Price	10,659,330	16,150,500	48,481,500
Maximum Competitive Price	4,225,236 (at DOC of Saab340)	5,596,569 (at DOC of Saab2000)	32,902,270 (at DOC of av.aircraft)

As can be seen in Figure 4.15, there is a considerable decrease of capital related to direct operating costs (DOC 1) of WIG craft. Yet the former calculated DOC 1 of WIG craft falls to 90.1%, 89.4% and 87.5% among the total DOC. This calculated DOC 1 of WIG craft applied to deduced the price of WIG crafts accounts for 78.4%, 74.5% and 82.5% respectively.

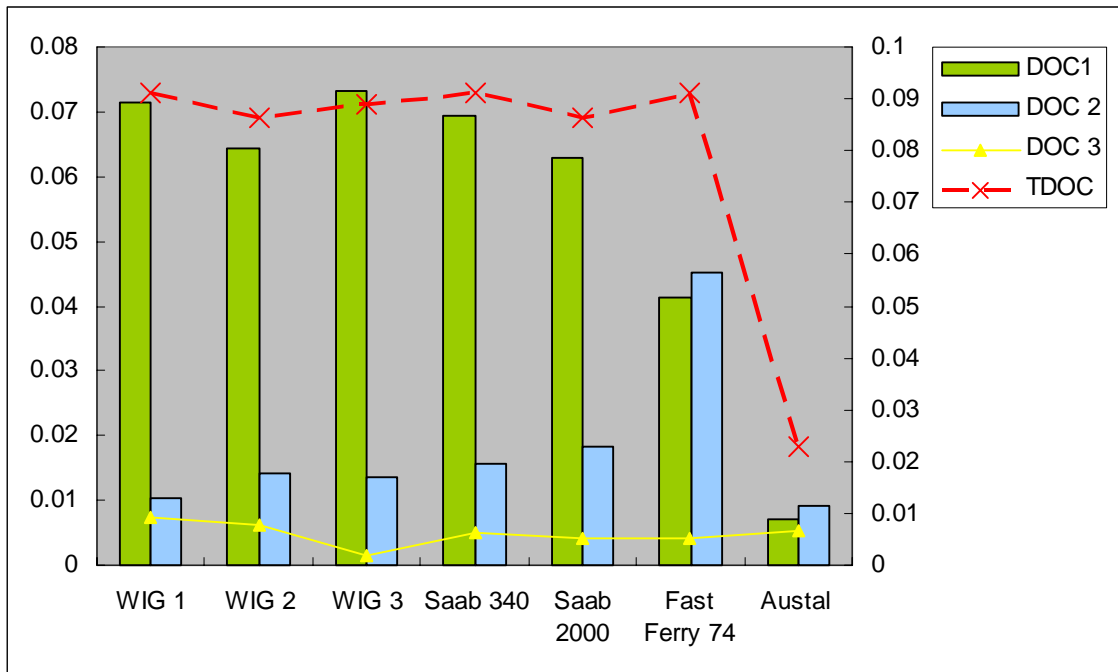

Figure 4.15 - Comparison of DOC at Maximum Competitive Price of WIG craft

Another point relating to the maximum competitive price of WIG craft is that there is a close co-relation between the speed and competitive price of WIG craft as can be seen from the following Figure 4.16, which can be construed that on the whole the maximum competitive price of WIG craft is becoming higher as the speed of them gets faster. In particular, there is a strong co-relation between speed and maximum competitiveness of the price of WIG 3 type, which has comparatively more passenger seats than those of WIG 1 and WIG 2 craft.

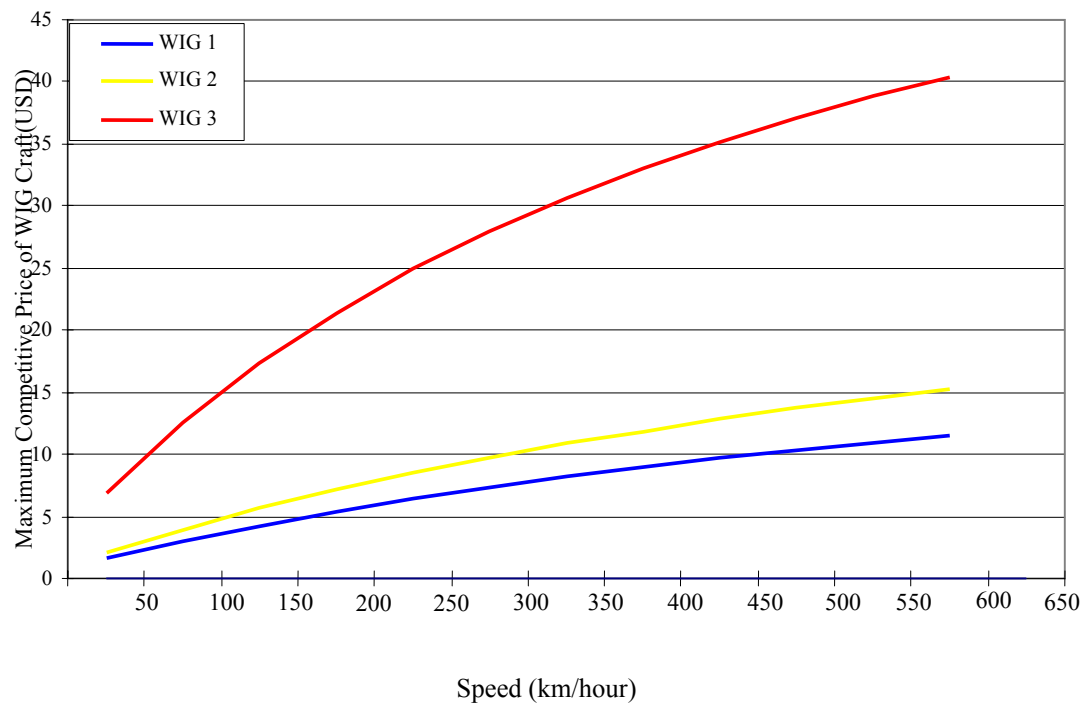

Figure 4.16 - The Co-relation Between Speed and Maximum Competitive Price of WIG

Finally, it should be suggested that the prices of WIG craft be lower than about one third of those of the equivalent aircraft in order for WIG craft, in particular the types of WIG 1 and WIG 2, to become commercially successful in the competitive market. For WIG 3 type, it is proved that provided the price of the WIG craft falls to 67.9% of the price of

the equivalent aircraft, the WIG craft has the competitive power. In addition, it is recommended that the portion of DOC 1 not be exceeded about 80% of the total direct operating cost.

4.3 Conclusions

To summarize, it is clear that the WIG craft has a potential to fill the gap between ship and aircraft. According to several Karman-Gabrielli Diagrams, the WIG craft seems to have theoretically enough economic reasonableness compared to other vehicles. Moreover, the transport productivity of the WIG craft in terms of payload ratio as well as fuel efficiency shows satisfactory results in order for the WIG craft to be commercialized.

Moreover, various values of transport effectiveness and the transport factor, which are useful tools for the evaluation of economic efficiency of the WIG craft, show relatively high efficiencies among other vehicles. Besides, the seaworthiness of WIG craft, which affects directly practical utilization of WIG craft, can be relatively accepted. In conjunction with the above efficiencies, size and speed of WIG craft play an important part to improve these efficiencies. Indeed, it may be said that the WIG craft is in an invulnerable position out of other vehicles and it has theoretical economic reasonableness to be commercialized.

In order to examine economic reasonableness of WIG craft from practical standpoint, the direct operating costs of WIG craft have been analyzed compared with those of aircraft and fast ferries using Akagi's formula according to two cases. Because of the difficulty to estimate the price of the WIG craft without any reliable information, the prices of WIG craft have been estimated by the formula originated from aviation statistics first, and then all factors of DOC of WIG craft have been compared to those of

aircraft and fast ferries and finally maximum price of WIG craft, which has the competitive power, has been deduced.

To conclude, it seems that price of the WIG craft has definitely had a tremendous impact on the direct operating costs of WIG craft, albeit, in conjunction with a niche market where there is no competition, a range of prices of WIG craft can become more unrestricted. It follows that provided price level of WIG craft is similar to that of air craft or is not below the above analyzed maximum competitive price out of the open competitive market, it clearly heavily weakens the commercial competitiveness of WIG craft.

In addition, it is evident that the maximum competitive price of WIG craft depends upon the speed and payload of WIG craft to no small extent, therefore it should discreetly be considered so that WIG craft can be expected to succeed commercially. Last of all, it comes as a surprise that fuel related cost does not noticeably affect the total DOC of WIG craft as much as it was expected in this model. Therefore, it can be concluded that the price of the WIG craft is matter of the most importance in order that WIG craft can be commercialized successful in the open competitive market.

CHAPTER FIVE

SAFETY RELATED MATTERS

5.1 Introduction

Needless to say the primary concern for operation of WIG craft is related with safety matters as with other conventional ships. It can be said that no matter how many advantages it has, there is no viability about commercialization of WIG craft without full assurance about its safety. From this point of view, safety and related matters on WIG craft, in particular operational aspects, human element and safety assessment including safety management are studied in this chapter.

5.2 Operational Aspects

5.2.1 Safe Operating Height

Cruising just above the water, the WIG craft is likely to be damaged due to contact with rogue waves. Yet often it would not seem to be the case that the WIG craft may get into danger if it collides with waves during cruising at high speed. In order to minimize the chance of the wave impact at high speed, the WIG craft should operate above the safe operating height.

From the Russian operational experience, safe operating height is recommended as follows:⁹⁷

$$h = \left(\frac{H_{3\%}}{2} \right) + (0.1 \cdot c) \quad (5.1)$$

where,

$H_{3\%}$ - $1.54 H_{1/3}$ ($H_{1/3}$ is the significant wave height.)

c – wing chord

The significant wave height is the average height of the one-third highest waves valid for the indicated twelve-hour period. As can be seen from the above formula, the safe operating height depends on the significant wave height and its wing chord. In case this height is higher than that of the ground effect of a WIG craft, the WIG craft cannot operate using the ground effect. Therefore, it should be underlined that the WIG craft should keep up the minimum safe operating altitude for the sake of safety as well as economic efficiency during cruising.

What is more, if ever, the WIG craft get in contact with rogue waves, the structure should be proof against it so as not to be in danger. Indeed, based on the above formula, it can be justified that the WIG craft needs to be large in order to increase safe operating height as well as seaworthiness.

5.2.2 Collision Avoidance

As can be seen from Figure 5.1, there are two types of maneuvers of the WIG craft to avoid collision with obstacles; one is the horizontal maneuver and the other is fly-over

⁹⁷ Halloran, M., & O'Meara, S. (1999). *supra* note 14.

maneuver. The type “A” WIG craft categorized by the Interim Guidelines for WIG craft by IMO has obviously only the former ability; on the other hand, type “B” and “C” WIG craft can avoid obstacles in both ways. Since the turning radius of the WIG craft is comparatively large on the ground that the bank angle of the WIG craft is limited to possible touchdown with surface, it is underlined that sophisticated and precise detection system is necessary so that the WIG craft may take avoidance action promptly followed by identifying obstacles.

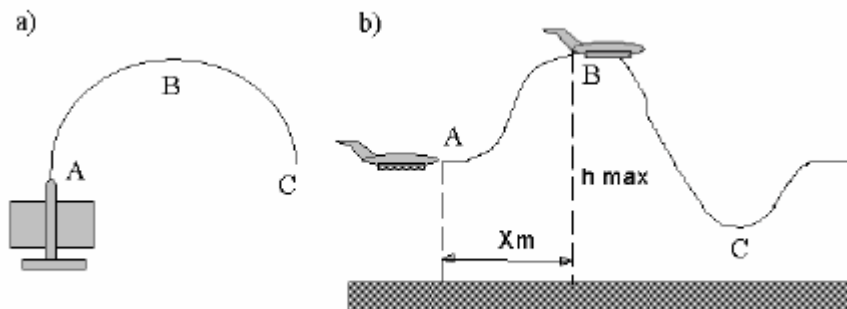

Figure 5.1 - Two Types of Maneuvers to Avoid Collision (a: Horizontal, b: Vertical)

(Source: *Kornev and Matveev (2003)*)⁹⁸

It may be said that safety concerns related to collision avoidance of the WIG craft is the primary safety problem from an operational aspect point of view. As a matter of fact, some people have occasionally raised doubts about safety concerns connected with the danger of WIG craft operations for the reason of possible collision with other ships.⁹⁹ However, according to Bogdanov (1996), it has been maintained that for more than 10 years of operation experience of the WIG craft in Russia, there has never been an

⁹⁸ Kornev, N., & Matveev, K. (2003). Complex Numerical Modeling of Dynamics and Crashes of Wing-In-Ground Vehicles. In *proceedings of 41st Aerospace Science Meeting and Exhibit, Reno, Nevada*: American Institute of Aeronautics and Astronautics.

⁹⁹ Bogdanov, A. (1996). Discussion on the Operational Aspects of WIG Craft at the IMO Sub-Committee on Safety of Navigation. In *workshop proceedings of Ekranoplan and Very Fast Craft, (pp.213-219)*, Sydney : University of New South Wales.

accident involving collision with any vessels owing to the high speed motion of the WIG craft, precise maneuverability, vertical jump-up mode and sophisticated navigation system.

In addition, as mentioned in Chapter three, the WIG craft has been interpolated into COLREG 1972, which entered into force on 29 November 2003. According to the amended COLREG 1972, the WIG craft is obligated to exhibit a high-intensity all-round flashing red light when taking off, landing and in flight near the surface along with the navigation lights as conventional ships must do. Indeed, the meaning of the amended COLREG 1972 in terms of the WIG craft is that the WIG craft should take on its responsibilities and duties upon collision prevention and avoidance in accordance with the convention. Unlike the Interim Guidelines for the WIG craft, it is clear that the WIG craft must comply with the regulations of COLREG 1972 which is a mandatory convention.

Amstrong (1995)¹⁰⁰ raises doubts as to sea traffic safety of the WIG craft, the reason of which is that current marine radar can not display exact data about obstacles, thus, it is impossible to identify displayed images on the radar screen whether they are a supertanker, a small fishing vessel or a WIG craft. In connection with above problem, IMO has recently introduced the Automatic Identification System (AIS)¹⁰¹ which is used by the ship and vessel traffic system (VTS) in order to address the problem of identifying ships when not in sight e.g. at night, in fog or at distance by providing a means for ships to exchange ship's static information, such as IMO number, name, and call sign of the ship, dynamic information, such as position, course, speed, and other navigation status and voyage related information such as draft, cargo type, estimated

¹⁰⁰ Armstrong, N. A. (1995). On the Safety of Navigation Above the Sea. *In proceedings of International Symposium for Twenty-First Century Flying Ships. (pp.119-127)*. Sydney: The Institute of Marine Engineers.

time arrival, destination and route with other nearby ships and VTS stations. Obviously, AIS will improve the safety of ships from collision with other ships and WIG craft to a great extent because it provides identification and status of marine vehicles. In particular, regarding the WIG craft, considering its high speed and operation mode, AIS may be an extremely useful tool to prevent collision accidents with WIG craft or other ships. Likewise regulation 19.2 of SOLAS chapter five, regulation 12.14 of the Interim Guidelines for WIG craft prescribes that WIG craft should be provided with AIS.

However, although all passenger ships regardless of their size, are applied to regulations of SOLAS on AIS, small ships which are less than 300 gross tonnages engaged on international voyage, cargo ships of less than 500 gross tonnages not engaged on international voyage as well as fishing vessels are not applied to this regulation. It may be a problem for WIG crafts which are engaged on coastal areas where there are many fishing vessels and small ships around. Therefore, it is necessary that all vessels that navigate around a sea route of WIG craft should be provided with AIS to prevent collision accidents.

In addition, a voyage data recorder (VDR) which is to create and maintain a secure, retrievable record of information indicating the position, movement, physical status, and command and control of a ship is also prescribed in chapter five of SOLAS as well as regulation 12.15 of the Interim Guidelines for WIG craft. It may be said that although VDR does not directly assist in preventing collision accidents, it will play an important role to prove the main cause of a collision accident through marine casualty investigation, thus, it will clearly improve capabilities of collision avoidance of WIG craft at last.

¹⁰¹ IMO.(2000). *November 2000 Amendment (MSC.99(73)) to the International Convention for the Safety of Life at Sea* .

Furthermore, it is necessary to have VTS for operation of WIG craft within a costal area. The IMO guidelines¹⁰² for VTS define it as follows:

“Any service implemented by a competent authority, designed to improve safety and efficiency of traffic and the protection of the environment. It may range from the provision of simple information message to extensive management within a port or waterway.”

VTS is a marine traffic monitoring system of which three basic tasks are collection, evaluation and dissemination of data. For safety operations of WIG craft, VTS should be no mere simple information message provider but play an active role in collision avoidance within a port or waterway similar to air traffic control for aircraft. Indeed, it is recommended that VTS carry out extensive management for safety operations of WIG craft.

5.3 Human Element

It is well known that most of the maritime accidents are caused by human error. It means that although reliable technology has been developed, the fact much remains to be done in the field of the human element of the maritime industry. Indeed, the human element is the most important factor for maintaining safety operations of ships including WIG craft. In fact, it is within bounds to say that the possibility of commercialization of WIG craft in the cradle depends on the human element, namely, officers and crews who operate the craft safely.

¹⁰² IMO. (1997). *Guidelines for Vessel Traffic Service. IMO resolution A.857(20)*.

5.3.1 Aviation Accidents vs. Maritime Accidents

Since the WIG craft has characteristics of both an aircraft and a ship, it is quite reasonable to consider both aspects. As can be seen from Figure 5.2, made by Boeing, 56% of the accidents in commercial aircraft in the past ten years were caused by flight crew, i.e. human errors. Only 21% are caused by mechanical failure i.e. airplane and maintenance and 13% by weather conditions. However, Dismukes et al. (1999)¹⁰³ even estimate that human errors such particular as captain’s authority, crew climate, and decision skills contribute to 80% of all aviation accidents.

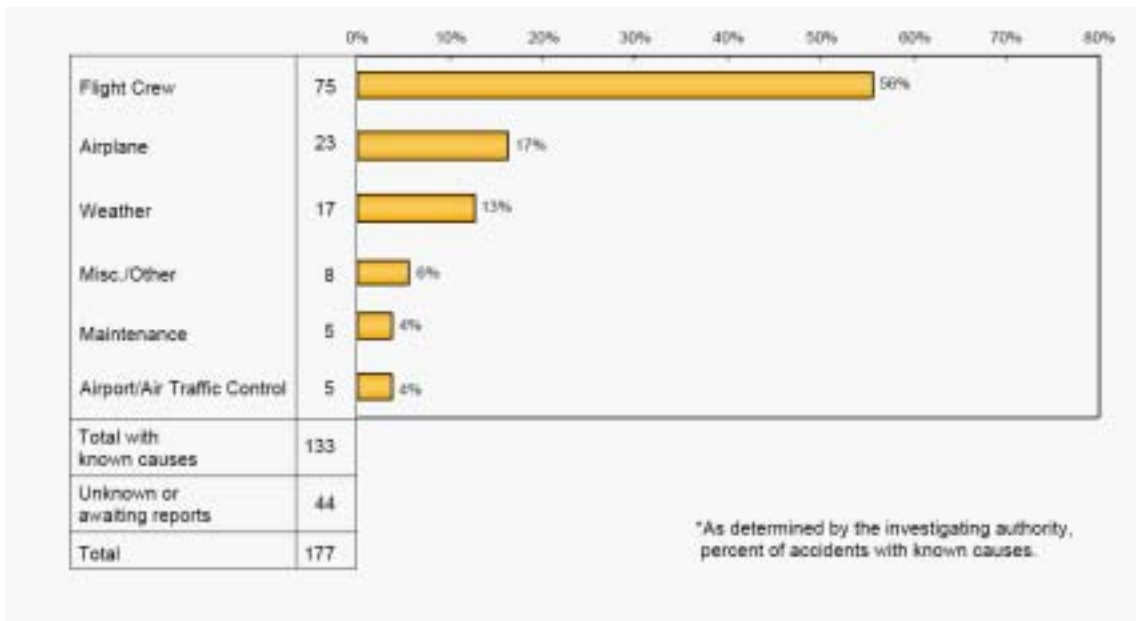

Figure 5.2 - Aircraft Accident by Primary Causes (Hull Loss Accident-World Wide Commercial Jet Fleet 1995 through 2004)

(Source: Boeing (2004))¹⁰⁴

¹⁰³ Dismukes, K., Young, G., & Sumwalt, R. (1999). Cockpit Interruptions and Distractions: Effective Management Requires a Careful Balancing Act. *Airline Pilot*, 68(5).

¹⁰⁴ Boeing. (2004). *Statistical Summary of Commercial Jet Airplane Accidents-World Wide Operations 1959-2004*. Retrieved Jun 27, 2006 from <http://www.boeing.com/news/techissues/pdf/statsum.pdf>

Subsequently, it can be seen from Figure 5.3 analyzed by UK P&I Club that 62% of the accidents among all maritime accidents resulted from human error. Therefore, it can be said that regardless of transportation, i.e. aviation or shipping what most accidents are caused by human error.

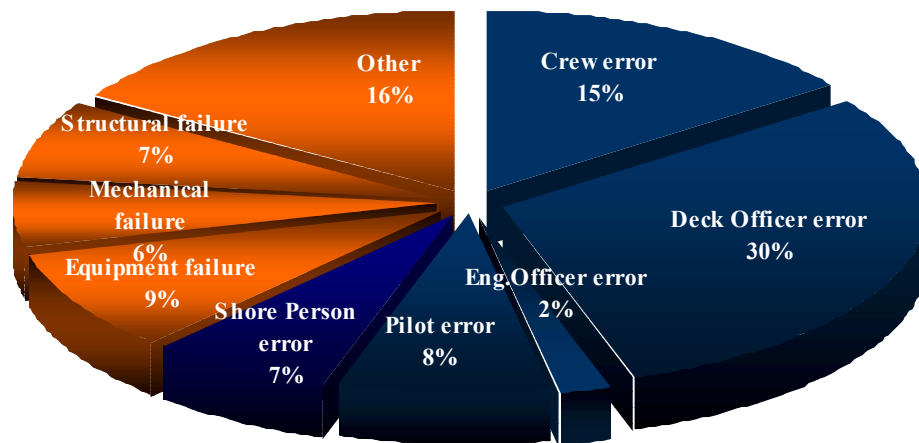

Figure 5.3 – The Root Causes of Maritime Accidents

(Source: UK P&I Club¹⁰⁵)

5.3.2 Performance Levels

According to Rasmussen (1983)¹⁰⁶, human performance and perception do not operate simply as an input-output device but rather, humans “*actively select their goals and seek the relevant information*” to address a problem. There are three types of behavior or psychological levels of performance developed by Rasmussen: skill-based, rule-based and knowledge-based performance.

¹⁰⁵ UK P&I Club. (1993). *Analysis of Major Claim*.

A skill-based performance is routine and highly practiced tasks in a largely automatic fashion. It requires no conscious control to carry out an action. Performance is automated and smooth and based on what operators learnt in the training program.

A rule-based performance is that stored rules and procedures which already exist in the operator's knowledge, are applied to a familiar work situation, namely, there are some pre-packaged solutions, e.g. Standard Operating Procedure (SOP), for estimated problems. However, it may be practically impossible to include every possible situation in pre-packaged solutions.

A knowledge-based performance is a more advanced level of performance that is applied to new or novel situations. The remains that are not covered by SOP should be applied flexibly judging from specific and complex situations. At this level, operators should understand the fundamental principles and regulations by which the situation is governed so that he can decide what must be done in an unexpected new situation. In this level, a positive attitude plays an important part in the decision-making or problem solving process.

According to experience of the aviation industry,¹⁰⁷ the main cause of accidents resulting from human error is neither lack of technical and operational skills referred to as skill-based performance nor checklists and manuals, describing SOP referred to as rule-based performance. Thus, it is known that the main cause of accidents is related to knowledge-based performance. In this context, it is noteworthy for a training program for officers of WIG craft to put emphasis on improving knowledge based performance, such as cockpit resource management or bridge resource management training.

¹⁰⁶ Rasmussen, J. (1983). Skills, Rules and Knowledge; Signals, Signs and Symbols and Other Distinctions in Human Performance Models, *IEEE Transactions on Systems, Man and Cybernetics*, 13:257-266, 1983.

5.3.3 CRM vs. BRM

During the 1970s, a number of aircraft accidents caused by human error relating to knowledge-based performance were identified.¹⁰⁸ As a countermeasure, Cockpit Resource Management (CRM) (or, Crew Resource Management) training was developed during the 1980s by the airlines and the National Aeronautics and Space Administration (NASA).¹⁰⁹ It can be said that the objective of CRM training is to improve crew performance relating to knowledge-based decision making so that unexpected situations regarding situational and sociopsychological factors can be coped with. Jensen describes CRM training as¹¹⁰:

“CRM training is not designed to change personality. Instead it is designed to address crew behavior, which is a product of knowledge and thought process, personality, attitude and background. In CRM course we can teach ways to think clearly in decision-making in concert with other crewmembers, each with a different personality, and we can have an impact on attitudes, which affect each of the areas of concern. Such training may result in more flexible behavior strategies and more coordinated crew behavior in critical situations when maximum effectiveness is a life or death issue.”

Today, all commercial pilots should attend CRM training in most parts of the world.

The Bridge Resource Management (BRM) Training concept was originally initiated from the CRM training concept of the aviation industry. It is an excellent example of adopting a system for improving safety from the experience of another industry. Based on the assumption that the CRM training concept could be applicable to the shipping

¹⁰⁷ Wahren, E. (1996). Fast Ferry Operation and the Human Factor, *In proceedings of 12th Fast Ferry International Conference*, Copenhagen: Fast Ferry International.

¹⁰⁸ von Thaden, T. (2004). *Developing a Methodology to Study Crew Information Behavior in Aviation*. (Rep. No. AHFD-04-13). Savoy, Illinois: University of Illinois at Urbana –Champaign.

¹⁰⁹ Wahren, E. (1996). *supra* note 107.

industry, the NTSB recommended on 14 March 1991, regarding marine casualty of Greek tankship M/V World Prodigy that the USCG require Bridge Resource Management training for deck officers and to propose to the IMO that STCW 1978 be amended to require BRM training.¹¹¹ Moreover, the SAS Flight Academy developed a Bridge Resource Management course in 1993.¹¹² Finally, the BRM concept has been included in the STCW Code Part B which is recommended guidance of the 1978 STCW as amended in 1995.

According to the report of Sub-Committee on Safety of Navigation,¹¹³ the main objectives of BRM are:

“to assist the ship master in managing the vessel’s bridge team for each voyage so that personnel are rested, trained and prepared to handle any situation, to help the ship master recognize workload demands and other risk factor that may affect decisions in setting watch conditions, to ensure bride team members are trained and aware of their responsibilities and to help bridge team members interact with and support the master and/or the pilot.”

BRM training is not navigation training, passage planning or maneuvering training but focusing on the functioning of crew, concentrating on crewmember attitude and behaviors, requiring active participation of all crew and providing an opportunity for crew to examine their behavior.

However, BRM training is not mandatory, i.e. just a recommendation. Even BRM training is not developed as an IMO model training course. Needless to say that for WIG

¹¹⁰ Jensen, R. S. (1995). *Pilot Judgment and Crew Resource Management*. Burlington, VT: Ashgate.

¹¹¹ The US National Transportation Safety Board Safety Recommendation (14 March 1991). (Rep. No. M91-6 and 7).

¹¹² Wahren, E. (1996). *supra* note 107.

craft, it is essential that CRM or BRM training be required so that accidents caused by human error, which is the main causation of the greater part of aviation and marine accidents can be minimized. For the reasons above, as CRM training is already required for commercial aircraft pilots for WIG craft safety, CRM or BRM training should be mandatory in the STCW Convention as well as IMO model training courses on this should be developed.

5.4 Safety Assessment

As can be seen from the Chapter three, the traditional prescriptive approach forming standard no longer provides a proper and cost effective standard for innovative transportation vehicles such as WIG craft. Instead, the safety case approach or flexible risk management is a more promising and effective way to secure safety of WIG craft and to promote development of new technology as well as to accelerate its commercialization. In this connection, it can be said that the safety assessment process is one of the most important parts in the safety case approach.

In the Interim Guidelines for WIG craft,¹¹⁴ although there are some prescriptive recommendations which may be accepted as general risk control measures, it is clear that risk control measures developed by the safety assessment process will usually be the requirement applying to a specific WIG craft. Even risk control measures may override prescriptive recommendations. Thus, the safety assessment process is an essential part to develop specific requirements for WIG craft.

¹¹³ IMO Sub-Committee on Safety of Navigation. (30 April 2004). (Rep. No. NAV/50/11/1).

¹¹⁴ IMO. (2002). *supra* note 41.

5.4.1 Safety Assessment Process

Like the BRM training concept, the safety assessment process is also originally from aviation regulations.¹¹⁵ The purpose of the safety assessment process is to ensure that every relevant function and the system designs of WIG craft are completely examined. According to the Interim Guidelines for WIG craft, there are three phases and three different processes, which are used in the phases of the development cycle as is shown in Table 5.1.

Table 5.1 - Relationship Between Safety Assessment Processes and the Different Phases of the Development Cycle (Source: *IMO (2002)*)¹¹⁶

Assessment process:	Functional Hazard Assessment (FHA)	Preliminary System Safety Assessment (PSSA)		Design implementation	<i>System Safety Assessment (SSA)</i>
Purpose of process	<ul style="list-style-type: none"> - Identify and classify failure conditions - Establish safety objectives 	<ul style="list-style-type: none"> - Establish system and item safety requirements - Develop specifications for hardware procurement 			<ul style="list-style-type: none"> - Verify that safety requirements defined in FHA and PSSA are satisfied
Development cycle:	<i>Concept development</i>	<i>Preliminary design</i>	<i>Detailed design</i>	<i>Procurement</i>	<i>Design validation</i>

¹¹⁵ Aerospace Recommended Practice 4761: *Guidelines and Methods For Conducting the Safety Assessment Process on Civil Airborne Systems and Equipment*, Society for Automotive Engineers (SAE), 1996.

¹¹⁶ IMO. (2002).*supra* note 41.

The Functional Hazard Assessment (FHA) is to identify failure conditions, e.g. malfunction of propulsion power, loss of electricity and to classify failure conditions, i.e. minor, major, hazardous, and catastrophes. As a result, safety objectives can be established using the probability concept. The Preliminary System Safety Assessment (PSSA) is to review proposals resulting from the FHA process, to establish systems and safety item requirements and to develop specifications for hardware purchase. Finally, the System Safety Assessment (SSA) is to confirm and verify whether the developed safety requirements from the FHA and PSSA are satisfied.

It is recommended that a number of established assessment methods be used to support the assessment processes such as Fault Tree Analysis (FTA) or Dependence Diagrams (DD), Failure Modes Effect and Criticality Analysis (FMECA), Failure Modes and Effects Summary (FMES) and Zonal Hazard Analysis (ZHA).¹¹⁷

From an experience of Germanischer Lloyd (GL),¹¹⁸ the machinery and electrical systems of a WIG craft were assessed based on prescriptive regulations and additionally SSA was considered. Thus, it may be said that the safety concept of WIG craft consists mainly of four elements, namely, a core of prescriptive requirements, a deliberate assessment process and requirements drawn from the assessment and safety management.

5.4.2 Safety Management

In order to maintain safety standards established by safety assessment and/or prescriptive requirements during operation, the safety management system relating to

¹¹⁷ *Ibid.*

¹¹⁸ Fach, K., Petersen, U., & Reischauer, H. (1999). Classification Experience with an 8 Seater WIG Craft. *In proceedings of Fast 99, Fifth International Conference on Fast Sea Transportation 1999 (pp.339-349)*, Seattle, Washington.

operational procedures, regular checks and maintenance tasks should be established and implemented. The safety management system is not new but already an existing safety regime in the SOLAS Chapter nine and the International Safety Management (ISM) Code. It may be said that safety management means systematic documented systems established by the company enabling the company and its personnel to implement and maintain the company policy regarding safe management and operation of WIG craft and pollution prevention.¹¹⁹ However, unlike safety assessment, safety management does not make any new technical requirements but rather, it should be established and implemented based on results from the PSSA and SSA.

As a matter of fact, the ISM Code has been made with concerns about poor management standards in shipping and marine casualties resulting from human error. Accordingly, it has focused on implementation of operational requirements such as operation procedure, emergency preparedness, and training of crew. Considering that, as mentioned in Chapter 5.2, most accidents are caused by human error, safety management is a matter of great significance.

On the whole, it should be underlined that safety management for WIG craft as a mean for effective implementation of safety requirements drawn by PSSA and SSA is a process for the completion of safety of WIG craft.

5.5 Conclusions

To sum up, it is not too much to say that the safety matter is the most important factor for viability of commercialization of WIG craft. The primary concern for safety of WIG craft is on collision avoidance. However, it would seem that there are no apparent technological barriers to the successful design and operation of WIG craft to make it

¹¹⁹ IMO. (1997). *International Safety Management Code*.

possible to avoid collision accidents. In this connection, WIG craft should be capable of maintaining the minimum safe operating altitude, detecting an obstacles and avoiding collision.

AIS, VTS and VDR introduced recently would undoubtedly improve the safety of WIG craft. Therefore, it is recommended that small ships as well as fishing vessels which are not obligated to abide by those regulations relating to AIS and VDR be provided with these systems. Moreover, VTS should carry out extensive management, not just simple message provider, for safety operations of WIG craft,

In the light of statistics of maritime and aviation accidents, human error contributes to most of the accidents. It is shown that aviation accidents caused by human errors result from lack of knowledge based performance mostly. Thus, CRM or BRM training which focuses on knowledge based performance is needed for officers of WIG crafts.

The safety concept of WIG craft consists of a core of prescriptive requirements, deliberate safety assessment and requirements drawn from assessment and safety management. Safety assessment is a process to evaluate the safety of WIG craft and to develop specific requirements. Thus, it is required that reliable safety assessment and safety management that maintain standards established by safety assessment be put in force.

CHAPTER SIX

CONCLUSIONS

The commercial viability of the WIG craft in relation to the technical, economic, and safety matters has been examined. The historical and legal aspects have also been studied in this dissertation.

The WIG craft has really attractive characteristics filling a very interesting speed range between 80 knots and 300 knots with good efficiency by virtue of the ground effect phenomenon. In spite of the fact that the phenomenon was found early in the 1930s, practical applications of the WIG craft have been undertaken since the 1960s. In fact, the development of the WIG craft for civil use commenced in the 1980s. It can be said that WIG craft have become more efficient and have better seaworthiness when they are bigger. Nevertheless, although Boeing has plans to develop huge WIG craft, mainly only smaller recreational and ferry WIG craft have been developed for commercial use up to date, the main reason of which is that there is too little practical experience of commercial operations of WIG craft to develop huge WIG craft, which need high capital cost to be developed.

Theoretically, it is obvious that WIG craft are more efficient than equivalent aircraft and faster than equivalent marine vehicles due to the ground effect. Evidently, the lift to drag

ratio and Breguet range of WIG craft show high efficiency as discussed in Chapter two. The problem of stability and controllability for the WIG craft was the major technical barrier to develop it in the past; however it seems that these problems can be surmounted by current aeronautic technology. The hydrodynamic drag of the WIG when it takes off is the primary disadvantage, which gravely undermines the efficiency of the WIG owing to the large amount of power required for take –off. Thus, it is necessary that lift aids that make the WIG craft take off more easily be developed and employed.

As discussed in Chapter three, International legislation on WIG craft is quite necessary to support commercialization of WIG craft. Although several regulations for WIG craft were recently developed and amended, there are still some problems from a legal standpoint. The Interim Guidelines for WIG craft are not mandatory regulations but just recommendations. In order to promote commercial operation of WIG craft and encourage harmonized application of regulations, the Guidelines should become compulsory with the development of WIG craft. Moreover, the Guidelines are not applicable to type “C” WIG craft. Considering that type “C” WIG craft has the same operational mode as the other WIG craft except aircraft mode, it is recommended that regulations for type “C” WIG craft be enacted. When it comes to the STCW Convention, mandatory STCW regulations for officers on WIG craft should also be made. In addition, there are not any regulations or recommendations for officers on small and large WIG craft. Therefore, it is recommended that regulations for these WIG craft be established. An approach that already requires attention is that the safety case approach is a way to a right regulatory regime for WIG craft which is considerably different from conventional ships on the ground that the strict prescriptive regulations may impede the progress of commercialization of WIG craft and interfere with development of novel technology of such a vehicle. Therefore, the safety case approach for enactment of international regulations for WIG craft is certainly in order rather than the conventional strict prescriptive approach.

It is significantly important to analyze the economic reasonableness for commercial operation of WIG craft as discussed in Chapter four. The economic reasonableness for WIG craft has been analyzed in both theoretical and practical ways. The WIG craft has theoretically economic reasonableness compared to other marine and aviation vehicles. Karman-Gabrielli Diagrams, which are a classical method to analyze efficiencies of a transport medium, show that the WIG craft has a potential to fill the gap between ships and aircraft. Beyond that, the values of transport productivity, which demonstrates economic efficiency in terms of payload weight and speed, and transport effectiveness which shows efficiencies of in terms of payload, cruising velocity, propulsive power, relative fuel expenditure and passenger capacity, show relatively higher efficiencies than those of other vehicles. In conjunction with the above efficiencies, size and speed of the WIG craft exert a great influence on these efficiencies. It may be given as a conclusion that the WIG craft has theoretical economic reasonableness to be commercialized.

Next, cost analysis of a modeled route has been made to appreciate economic reasonableness of commercial operation of WIG craft from a practical economic standpoint. It has been found that the price of WIG craft is the most important factor which exercise an influence on direct operating cost of WIG craft in this model under the open competitive market environment with aircraft and fast ferries. The WIG craft may be competitive to attract passengers only when its price is reasonable. In this context, the price of WIG craft should be lower than that of equivalent aircraft to such extents so that WIG crafts may have competitive advantage with aircrafts, which will result in commercialization of WIG craft successfully. Moreover, like the preceding theoretical economic analysis, the speed and payload of the WIG craft significantly affect its competitive edge from an economic standpoint.

Direct operating costs of the WIG craft are not notably affected by fuel related costs in this model. This is because the distance of the model is relatively short as well as the model WIG craft which were made in the former USSR not for commercial use seem not to take full advantage of the ground effect phenomenon. In this connection, the commercial WIG craft is in need of making the most of the ground effect in order to improve competitiveness.

Apart from this, in conjunction with a niche market where there is no direct competition, e.g. operation between island to island where there is no airdrome, recreational use and rescue use, a range of competitive direct operating costs and price of WIG craft can be become more unlimited.

On the whole, it may be said that the WIG craft is theoretically in an invulnerable position from an efficiency point of view, *inter alia*, and it is quite possible to have practical economic reasonableness to be commercialized under the above mentioned conditions.

The safety matter is the most important factor for viability of commercialization of the WIG craft. Provided that safety of the WIG craft is in question, it is useless no matter how much greater economy the WIG craft has. Collision avoidance is a matter of great importance for the safety of the WIG craft. By virtue of current technology, it seems that there are no conspicuous technological obstacles to make the WIG craft possible to avoid collision accidents. In addition, AIS, VTS and VDR, which have recently been introduced by IMO, obviously would enhance the safety of the WIG craft in terms of collision avoidance. However, small ships, less than 300 tonnages engaged on international voyage and less than 500 tonnages not engaged on international voyage and fishing vessels have no obligation to follow the regulations about AIS and VDR, thus, these ships may incur potential danger involved in safety operation of the WIG

craft. Aside from it, although regulations about AIS and VDR have been made in the Interim Guidelines for WIG craft, they are not mandatory regulations. What is worse, the WIG craft of Type “C” is not applicable to these Guidelines. Therefore, it is recommended that all WIG craft including Type “C”, small ships and fishing vessels be applicable to the regulations about AIS and VDR. Furthermore, VTS should carry out extensive management, not just a simple message provider, for safety operations of the WIG craft,

The statistics of maritime and aviation accidents show that most cases of accidents have their roots in human error. Besides, it is shown that human error results mostly from lack of knowledge based performance. Therefore, Cockpit Resource Management (CRM) and Bridge Resource Management (BRM), which are focused on knowledge based performance training, are needed for officers of WIG craft so as to prevent accidents caused by human error.

The safety concept of the WIG craft is composed of a core of prescriptive requirements, safety assessment, requirements drawn from the assessment and safety management. Safety assessment is the most important process to evaluate safety and to develop specific requirements for a WIG craft. Thus, it is required that reliable safety assessment and safety management that maintain established standards be developed by the safety assessment process put in force for safety operations of the WIG craft which is essential for commercial operations of the WIG craft.

Finally, it is required that exclusive port facilities for WIG craft, i.e. waterways, ramps, piers, cargo handling machine and platform for passengers be needed in order for WIG craft to be operated commercially. It is necessary to further discuss on this issues of port requirements for WIG craft.

REFERENCES

- Advance Research Projects Agency (ARPA), U.S. (1994). *Wingship Investigation Volume 1-Final Report*, (AD-A294979). Utica, NY: Author
- Advanced Vessel Technologies. (2000). *Advanced vessel technologies: Program element 2.3.1: High speed searift design evaluation and analysis*. Tuscaloosa, AL: University of Alabama.
- Akagi, S. (1993). A Study of Transport Economy and Market Research for High Speed Marine Passenger Vehicles. *Proceedings of Fast 93, Second International Conference on Fast Sea Transportation*. (pp.1129-1142). Yokohama: Society of Naval Architects of Japan.
- Alexander, H. D., & Lawrence, J. D. (2002). A Study of the Efficiency of the Wing-In-Ground-Effect Concept. *Proceedings of International Conference on Twenty-First Century Flying Ships* (pp.1-21). Sydney: Institute of Marine Engineers (Sydney Branch).
- Amstrong, N. A. (1995). On the safety of navigation above the sea. *Proceedings of International Symposium for Twenty-First Century Flying Ships* (pp.119-127). Sydney: The Institute of Marine Engineers (Sydney Branch).
- Amyot, J. R. (Ed.). (1989). *Hovercraft technology, economics and applications*. Amsterdam: Elsevier Science Publishers B.V.
- Ando, S. (1988, May). Some thoughts on power-augmented-ram WIG effect vehicle. *Transactions of the Japan Society for Aeronautical and Space Science*, 31, 29-47.
- Basin, M. (1997). WIG (Ecranoplane) as a transport vessel and sport craft. *Proceedings of International Symposium and Seminar for the Safety of High Speed Craft*, (pp. 1-12). London: Royal Institution of Naval Architects.
- Basin, M., Kramerov, E., & Latorre, R. (1997). WIG (Ecranoplane) as a transport vessel and sport craft. *Proceedings of International Symposium and Seminar for the Safety of High Speed Craft* London: Royal Institution of Naval Architects.
- Bishop, P. G. & Broomfield, R. E. (1995). The SHIP safety case approach. In G. Rabe (ed.), *SafeComp95, Belgirate, Italy 11-13 October 1995*, (pp. 437-451). Munich: Springer

- Bogdanov, A. I. (1995). The problems of ekranoplans certification, conception and development of IMO safety requirements. *Proceedings of International Symposium for Twenty-First Century Flying Ships* (pp. 128-147). Sydney: Institute of Marine Engineers (Sydney Branch).
- Bogdanov, A. I. (1996). Discussions on the operational aspects of WIG craft at the IMO Sub-Committee on Safety of Navigation. *Workshop Proceedings of Ekranoplans & Very Fast Craft, University of New South Wales, Sydney, Australia, 5-6 December* (pp.213-229). Sydney: Sydney: Institute of Marine Engineers (Sydney Branch)
- Bogdanov, A. I. (2000). Rules of Classification and Construction of a Type “A” Small Ekranoplans of the Russian Maritime Register of Shipping – a First in the World the Regulatory Document for Civil Ekranoplans. *Proceedings of GEM 2000 International Conference*, (pp.73-80). St. Petersburg, Russia: Marine Technical University and The Institute of Marine Engineers.
- Boeing Information on Cost of the Boeing Jetliners, (June 6, 1996).
- Boeing. (2004). *Statistical Summary of Commercial Jet Airplane Accidents-World Wide Operations 1959-2004*. Retrieved June 27, 2006 from <http://www.boeing.com/news/techissues/pdf/statsum.pdf>
- Carter, A. (1961). *Effect of ground proximity on the aerodynamic characteristics of arl aerofoils with and without end plates* (NASA TN D-970). Washington, DC: National Aeronautics and Space Administration
- Chun, H., Park, I., Chung, K., & Shin, M. (1996). Computational and experimental studies on wings in ground effect and a wig effect craft. *Workshop Proceedings of Ekranoplans & Very Fast Craft, University of New South Wales, Sydney, Australia, 5-6 December* (pp.38-59). Sydney: Institute of Marine Engineers (Sydney Branch)
- Chubikov, V., Pashin, V., Treshchevsky, V., & Maskalik, A. (1991). Ekranoplan: A high-speed marine vehicle of a new type. *Proceedings of First International Conference on Fast Sea Transportation*, (pp.641-648). Trondheim, Norway: [s.n.]
- Chun, H.H., & Kim, H. J. (2000). Aerodynamic optimization of wing in ground effect craft. *Proceedings of GEM 2000 International Conference* (pp. 81-98). St. Petersburg: Marine Technical University and Institute of Marine Engineers.
- Cole, W. (2002, September). Phantom works: The pelican-a big bird for the long haul. *Boeing Frontiers*, 1 (5). Retrieved June 28, 2006, from http://www.boeing.com/news/frontiers/archive/2002/september/i_pw.html

- Day, A. H., & Doctors, L. J. (1995). A study of the efficiency of the Wing-In-Ground-effect concept. *Proceedings of International Symposium for Twenty-First Century Flying Ships* (pp.1-22). Sydney: Institute of Marine Engineers (Sydney Branch)
- Dismukes, K., Young, G., & Sumwalt, R. (1998). Cockpit interruptions and distractions: Effective management requires a careful balancing act. *Airline Pilot*, (10), 4-9.
- Fach, K., Petersen, U., & Reischauer, H. (1999). Classification experience with an 8 seater WIG craft. *Proceedings of Fast 99, Fifth International Conference on Fast Sea Transportation 1999, Seattle, Washington* (pp.339-349). Seattle, Washington: [s.n.]
- Fischer, H., & Matjasic, K. (1997). The Hoverwing technology bridge between WIG and ACV. *EAGES 2001 International Ground Effect Symposium, Toulouse, France, June 2001* (pp.1-7). London: The Royal Institution of Naval Architects.
- Gabrielli, G., & von Karman, TH. (1950, October). What price speed? *Mechanical Engineering*, 72 (10), 775-781.
- Green, W. J. (1997). *The imminent future of ultra-fast ferries is off the water: Breakthrough design offers better efficiency & maneuverability*. Paper presented to the International Conference on Air Cushion Vehicles and Wing-In-Ground Effect Craft sponsored the Royal Institution of Naval Architects in London, 3-5 December 1997.
- Halloran, M., & O'Meara, S. (1999). *Wing-In-Ground-Effect craft review* (Rep. No. DSTO-GD-0201). Melbourne: Defense Science & Technology Organization.
- Handler, E. H. (1976). Practical Considerations Regarding Wing-In-Ground effect aircraft. *Journal of Hydronautics*, 11 (2), 35-41.
- Hooker, S. (1982). Wingships: Prospect for High-Speed Oceanic Transport. *JANE's all the world's surface skimmers*. Surrey, UK: Jane's
- Hooker, S. (1995). Twenty first century shipping at aircraft speeds. *Proceedings of International Symposium for Twenty-First Century Flying Ships*, (pp.178-232). Sydney: The Institute of Marine Engineers (Sydney Branch).
- Hooker, S. F. (1996). Some thoughts on the commercialization of ekranoplans and wingships. *Proceedings of Ekranoplans and Very Fast Craft* (pp.272-299). Sydney: The Institute of Marine Engineers (Sydney Branch).

- International Civil Aviation Organization (ICAO). (1996). *Rules of the air* (13th Ed.) Montreal: Author
- IMO. (1997). IMO resolution A.857(20): Guidelines for Vessel Traffic Service. *Assembly resolutions and other decisions (Resolutions 839-873): Twentieth Session, 17-27 November 1997, London* (pp. 117-134). London: Author
- IMO. (1997). *International Safety Management Code (ISM Code): International management code for safe operation of ships and for pollution prevention*. London: Author
- IMO. (2000). *2000 HSC Code: International Code of Safety for High-Speed Craft, 2000: Resolution MSC.97(73) adopted on 5 December 2000*. London: Author
- IMO. (2001). *COLREG: Convention on the International Regulations for Preventing Collisions at Sea, 1972, as amended*. London: Author
- IMO (2003). *Relations with other organizations: IMO/ICAO cooperation with regard to the development of provisions for WIG craft (MSC 77/21/1)*. Paper presented at the Maritime Safety Committee, seventy-seventh session, 20th March 2003, London.
- IMO. (2004). *Large passenger ship safety: effective voyage planning for large ships: FSA large passenger ships: navigational safety (NAV/50/11/1)*. Paper submitted by the Sub-Committee on Safety of Navigation at its 50th session, 30 April 2004.
- IMO. (2005). *General Principles and Recommendations for Knowledge, Skills and Training for Officers on Wing-In-Ground (WIG) Craft Operating in Both Displacement and Ground Effect Modes (MSC/Circ.1162)*. Paper submitted to the Sub-Committee on Standards of Training and Watchkeeping, at its thirty-sixth session, 10 to 14 January 2005, London.
- IMO. Maritime Safety Committee, 73rd Session, 2000. (2000). *Resolution MSC.99(73), (adopted on 5 December 2000): Adoption of amendments to the International Convention for the Safety of Life at Sea, 1974, as amended MSC (73/21/Add.2)*. Resolution adopted at the Maritime safety Committee on the 73rd Session, 12 December 2000, London.
- IMO. Maritime Safety Committee, 76th, 2002. (2002). *Interim guidelines for Wing-In-Ground (WIG) craft (MSC/Circ.1054)*. Paper approved at the Maritime Safety Committee, seventy-sixth session, 2-13 December 2002, London.

- IMO acknowledges WIG craft in amended regulations. (2004, January/February). *Ship and Boat International*, 39.
- Jensen, R. S. (1995). *Pilot Judgment and Crew Resource Management*. Burlington, VT: Ashgate.
- Kennel, C. (1998). Design trends in High-Speed transport. *Journal Marine Technology*, 35 (3), 127-134.
- Korea Occupational Outlook (2005), and ITF TCC Wage Scale (2006).
- Kornev, N. & Matveev, K. (2003). Complex numerical modeling of dynamics and crushes of Wing-In-Ground vehicles. *Proceedings of 41st Aerospace Science Meeting and Exhibit, Reno, Nevada, 6-9 January 2003* (pp.1-9). Reno, Nevada: American Institute of Aeronautics and Astronautics.
- Kubo, S. (1993). A concept of Wing-In-Surface-Effect craft as a future passenger transport in Japan. *Proceedings of Fast 93, Second International Conference on Fast Sea Transportation*. (pp.1573-1584). Yokohama: The Society of Naval Architects of Japan.
- Losi, P. C. (1995). *The Wingship's potential for strategic lift*. Washington, D.C.: The Industrial College of the Armed Forces, National Defense University.
- Malyshev, M. I. (1995). Experience of using ekranoplans in Russian navy. *Proceedings of International Symposium for Twenty-First Century Flying Ships*. (pp.233-244). Sydney: The Institute of Marine Engineers (Sydney Branch).
- Mayer, L. (1996). Navigation & safe operation of very fast craft – The need for a safety case? *In proceedings of Ekranoplans and Very Fast Craft*, (pp.194-212). Sydney: The Institute of Marine Engineers (Sydney Branch).
- Mellow, C. (1996, December/January). When ship have wings: The Russians give the term “flying boats” a whole new look. *Air & Space*. Retrieved June 28, 2006 from: <http://www.airspacemag.com/search.php>
- Papanikolaou, A. D. (2001). Developments and potential of advanced marine vehicles concepts. *Bulletin of the KANSAI Society of Naval Architects, Japan*, (55), 50-54.
- Papakirillou, A., & Papanikolaou, A. (2001, May). Revisions to the High Speed Craft Code. *Motor Ship*, 56-59.

- Rasmussen, J. (1983). Skills, rules and knowledge; signals, signs and symbols and other distinctions in human performance models. *IEEE Transactions on Systems, Man and Cybernetics*, 13, 257-266.
- Rozhdestvensky, K. V., & Synitsin, D. N. (1993). State-of –the-Art and perspectives of development of ekranoplans in Russia. *Proceedings of Fast 93, Second International Conference on Fast Sea Transportation* (pp.1657-1670). Yokohama: The Society of Naval Architects of Japan.
- Rozhdestvensky, K.V. (1995). Ekranoplans: Flying ships of the next century. *Proceedings of International Symposium for Twenty-First Century Flying Ships*. (pp 47-70). Sydney: The Institute of Marine Engineers (Sydney Branch).
- Rozhdestvensky, K. V. & Kubo, S. (1997). A Parametric analysis of a flying wing configuration in extreme ground effect. *In proceedings of International Symposium and Seminar for the Safety of High Speed Craft* (pp.78-96). London: Royal Institution of Naval Architects.
- Rozhdestvensky, K.V., & Mikhailov, M.A. (1998). Virtual Na (WIG)ation. *Proceedings of Workshop on WISE up to Ekranoplan GEMs* (pp. 125-137). Sydney: The Institute of Marine Engineers (Sydney Branch).
- Scott, J. (2003). *Ground effect and WIG vehicles*. Retrieved June 15, 2006, from <http://www.aerospaceweb.org/question/aerodynamics/q0130.shtml>
- Sinitsyn, D., & Maskalik, A. (1996). The Ekranoplan is a new type of high speed water transport which can be used in all seasons. *Proceedings of Ekranoplans and Very Fast Craft*, (pp.152 -161). Sydney: The Institute of Marine Engineers (Sydney Branch).
- Society for Automotive Engineers (SAE). (1996). *Aerospace recommended practice 4761: Guidelines and methods for conducting the safety assessment process on civil airborne systems and equipment*. Washington, DC: Author
- Stinton, D. (1997). Heavy, long-haul operations using the air-sea interface. *Proceedings of International Symposium and Seminar for the Safety of High Speed Craft* (pp. 1-18). London: The Royal Institution of Naval Architects.
- Stopford, M. (1997). *Maritime economics*. London; New York: Routledge

- Taylor, G.K. (2000). *Wise or Otherwise? The Dream or Reality of Commercial Wing In Ground Effect Vehicles*. Paper presented at the *Proceedings of GEM 2000 International Conference*, St. Petersburg, Russia.
- WIG Page. (2003). Retrieved June 30 2006, from <http://se-technology.com/wig>
- Flight Safety Foundation (1991). *US National Transportation Safety Board Safety Recommendation, 14 March 1991* (Rep. No. M91-6 and 7). Alexandria, Virginia: Author
- UK P&I Club. (1993). *Analysis of major claims*. London: Author
- von Thaden, T. (2004). *Developing a Methodology to Study Crew Information Behavior in Aviation*. (Rep. No. AHFD-04-13). Savoy, Illinois: University of Illinois at Urbana –Champaign.
- Wing-In-Ground effect aerodynamics. (2003). *The WIG Page*. Retrieved June 15, 2006 from: <http://www.se-technology.com/wig/html/main.php>
- Wahren, E. (1996). *Fast ferry operation and the human factor*. Paper presented at the 12th Fast Ferry International Conference, 20-22 February 1996, Copenhagen.

Appendix A

Model	WIG 1	WIG 2 (Raketa2)	WIG 3 (A.90)	Saab 340	Saab 2000	NGA Fast Ferry 74	Austal Ferry
Number of Seats	34	50	150	34	50	450	430
Nominal . Speed km/h(knots)	150 (81)	150 (81)	400 (216)	528 (285)	685 (370)	65 (35)	56 (30)
Effective Speed Km/h (knots)	149 (80)	149 (80)	396 (214)	341 (184)	391 (211)	64 (34)	54 (29)
Engine Type	Turboprop	Turboprop	Turboprop	Turboprop	Turboprop	Diesel	Diesel
Installed Power(KW)	653	1324	11000	2610	5574	15040	2940
Spec. Fuel Cons. (g/kwh)	250	250	250	210	210	210	210
Fuel Cons. /hour (litres)	131	265	2200	449	901	2843	556
Fuel Cost(kg\$)	0.4	0.4	0.4	0.4	0.4	0.4	0.4
Vehicle Price				10.8(mil)	15.5(mil)	25(mil)	3.52(mil)
Terminal Hours per Service (hours) .	0.25	0.25	0.42	0.5	0.5	0.67	0.67

Appendix B

(Price unit : USD)

Model	WIG 1	WIG 2 (Raketa2)	WIG 3 (A.90)	Saab 340	Saab 2000	NGA Fast Ferry 74	Austal Ferry
DOC1	0.0997	0.1027	0.0597	0.0561	0.0493	0.0418	0.0070
K_s	10,659,330	16,150,500	48,481,500	10,800,000	15,500,000	25,000,000	3,520,000
r_v	0.1	0.1	0.1	0.1	0.1	0.1	0.1
A	14	14	14	14	14	14	14
r_{ins}	0.01	0.01	0.01	0.01	0.01	0.01	0.01
r_{int}	0.05	0.05	0.05	0.05	0.05	0.05	0.05
r_m	0.03	0.03	0.03	0.03	0.03	0.03	0.03
N_D	34	50	150	34	50	450	430
V_s	150	150	400	528	685	65	56
T_a	3234	3234	2087	1655	1416	3153	3233
DOC2	0.0103	0.0141	0.0147	0.0100	0.0105	0.0389	0.0092
C_{fu}	0.4	0.4	0.4	0.4	0.4	0.4	0.4
M_f	437	1413	11000	2043	2497	87477	9929
R	500	800	2000	2402	1898	2000	1000
DOC3	0.0063	0.0052	0.0014	0.0052	0.0039	0.0053	0.0062
S_c	34400	31300	28200	51600	46950	27001	27001
N_c	3	4	6	3	4	18	18
L_R	200	200	200	200	200	200	200
TDOC	0.1163	0.1220	0.0758	0.0713	0.0637	0.0860	0.0224

Appendix C

(Price unit : USD)

Model	WIG 1	WIG 2 (Raketa2)	WIG 3 (A.90)	Saab 340	Saab 2000	NGA Fast Ferry 74	Austal Ferry
DOC 1	0.1804	0.1858	0.1080	0.0693	0.0630	0.0414	0.0072
K_s	10,659,330	16,150,500	48,481,500	10,800,000	15,500,000	25,000,000	3,520,000
r_v	0.1	0.1	0.1	0.1	0.1	0.1	0.1
A	10	10	10	14	14	14	14
r_{ins}	0.015	0.015	0.015	0.01	0.01	0.01	0.01
r_{int}	0.05	0.05	0.05	0.05	0.05	0.05	0.05
r_m	0.03	0.03	0.03	0.03	0.03	0.03	0.03
N_p	34	50	150	34	50	450	430
V_s	149	149	396	341	391	64	54
T_a	2158	2158	1398	2073	1942	3233	3233
DOC 2	0.0103	0.0142	0.0135	0.0155	0.0184	0.0451	0.0092
C_{fu}	0.4	0.4	0.4	0.4	0.4	0.4	0.4
M_f	694.3	1413	10101	3163	4374	101536	9929
R	500	800	2000	2402	1898	2000	1000
DOC 3	0.0094	0.0078	0.0020	0.0064	0.0050	0.0052	0.0065
S_c	34400	31300	28200	51600	46950	27001	27001
N_c	3	4	6	3	4	18	18
L_R	200	200	200	200	200	200	200
TDOC	0.2002	0.2078	0.1235	0.0912	0.0864	0.0917	0.0229